

DRE

ISO
9001



DOOR CATALOGUE 2019

edition 2





folding doors FOLDE 10 - white matt

EXPLANATIONS:

























- | | | | |
|---|---|---|--|
|  | Panel construction doors , DRE - Cell veneer |  | Panel construction doors, CPL laminate |
|  | Frame construction doors, DRE - Cell veneer |  | Frame construction doors, CPL laminate |
|  | Entrance doors, DRE - Cell veneer |  | Entrance doors, CPL laminate |
|  | Technical doors, DRE - Cell veneer |  | Technical doors, CPL laminate |
|  | Panel construction doors, 3D veneer |  | Panel construction doors, natural veneer |
|  | Frame construction doors , 3D veneer |  | Frame construction doors, natural veneer |
|  | Entrance doors, 3D veneer |  | Entrance doors, natural veneer |
|  | Technical doors, 3D veneer |  | Glass doors |
|  | Panel construction doors, lacquered HDF board |  | Panel construction doors Sara Eco |
|  | Frame construction doors, Finish veneer |  | Smoke-proof technical doors |
|  | Panel construction doors, painted |  | Fire resistant |
|  | Frame construction doors, painted |  | Anti-burglary technical doors |

TABLE OF CONTENTS

FRAME CONSTRUCTION DOORS

Emena.....	5
Ena.....	6
Verano.....	7
Trevi.....	8
Triesta.....	9
Solte.....	11
NEW Reva.....	13
Nestor.....	15
NEW Auri.....	17
Elsa.....	19
Fosca.....	20
Premium.....	21
Piano.....	23
Scala.....	25
Sinco.....	27
NEW Verso.....	29
Vetro A.....	31
Vetro B.....	33
Vetro C.....	35
Vetro D.....	37

FRAME CONSTRUCTION DOORS NATURA

Vetro natura A.....	39
Vetro natura B.....	41
Premium natura.....	42
Dova natura.....	43
Scala A natura.....	44

FRAME CONSTRUCTION DOORS PAINTED

Lexa.....	45
NEW Berge.....	47
Even.....	49
Nestor.....	51
NEW Vetro E.....	53

FRAME CONSTRUCTION DOORS CPL LAMINATE

Tixa.....	55
Tizano.....	57

PANEL CONSTRUCTION DOORS

Rivia.....	59
NEW Galeria Alu.....	61
Aldea.....	63
Arte B.....	65
Carla.....	67
Blanco.....	69
Finea and Finea B.....	71
Deco.....	73
Modern.....	75
Kanon.....	77
Idea.....	79
Plus.....	81
Standard.....	83
Rim.....	85
Fano.....	86
Arte.....	87
Classic.....	88
Ascada.....	89
Lack.....	90-91

PANEL CONSTRUCTION DOORS NATURA

Duero natura Alu.....	93
Arte natura.....	95
Standard natura.....	96-97
Galeria natura.....	98-99
GALERIA natura ALU.....	100-101

PANEL CONSTRUCTION DOORS PAINTED

Duo.....	103
NEW Uni.....	105
NEW Fargo.....	107
NEW Binito.....	109

PANEL CONSTRUCTION DOORS CPL LAMINATE

Standard CPL.....	110
-------------------	-----

PANEL DOORS WITH VARIABLE HEIGHTS

Standard 10.....	111
Modern.....	112
Plus.....	113

SLIDING SYSTEM

Wall-mounted sliding system.....	114-115
Sliding system glass doors.....	116-117
wall-mounted sliding system SPAZIO CD.....	118-119
Sliding system, doors hidden in the wall (pocket system) PA.....	120-121

FOLDING DOORS

Folde.....	122-123
------------	---------

DOORS WITH HIDDEN DOOR FRAME

Sara Eco.....	124-126
---------------	---------

SIDE PANELS

Frame construction.....	127
Panel construction.....	128
Side panel Natura.....	129

TRANSOM LIGHTS AND SIDELIGHTS

TRANSOM LIGHTS AND SIDELIGHTS ..	130-131
----------------------------------	---------

INTERIOR ENTRANCE PANEL DOORS

Enter natura.....	132
Accessories.....	133
Enter/Solid.....	134-137
SOLID RC2.....	138-139

TECHNICAL DOOR LEAVES

Fire resistant door leaves Olimp.....	140-142
Fire resistant door leaves Athos.....	143
Anti-burglary, fire resistant door leaves Forca.....	144
Anti-burglary door leaves Forca B.....	145
NEW Metal fixed door frame.....	146
NEW Adjustable metal door frame.....	147
hybrid steel door frame.....	148

GLASS DOORS

Galla.....	149
Gracca.....	150
Gossa.....	151-152
Glass doors technical informations.....	153-154

DOOR FRAMES

NEW Fixed rebated door frames.....	155
Fixed non-rebated door frames.....	156
Adjustable door frames.....	157-158
NEW Adjustable door frames with variable heights.....	159
Adjustable non-rebated door frames.....	160
Adjustable non-rebated door frames With variable heights.....	161
Adjustable door frames with inverted rebate.....	162
Adjustable tunnel.....	164-165
Extension panel.....	166-167
Hybrid metal door frame.....	168-169
Adjustable metal door frame.....	170
Fixed metal door frame.....	171

ACCESSORIES, ADDITIONAL INFORMATIONS

Door handles.....	172-179
NEW Vener colours.....	180-181
Glass panes patterns.....	182-183
Architraves and skirting boards.....	184
Ventilation accessories and other.....	185
Technical informations.....	186-194



Emena - anthracite elm

Decor
DRE-Cell

white (structure)	white pine	siberian elm	sand oak	bleached oak textured	ash	vintage oak	caramel walnut	golden oak textured	dark walnut textured	gray oak textured***
tabac elm	anthracite elm	dark wenge	gray textured	black textured	*** decor available only in horizontal wood grain					

STANDARD OPTIONS

- » stiles and rails made of MDF
- » glass pane MAT DRE 4 mm thick

OPTIONS WITHOUT ADDITIONAL CHARGE

- » glass pane DECORMAT BROWN, DECORMAT GRAPHITE and transparent glass pane
- » holes for ventilation sleeves

REBATED DOOR LEAF

- » straight edge **fig. 1**
- » 3 silver screw-in pivot hinges
- » single-point mortise lock for simple key, for bathroom lock, for cylinder lock or economic lock

NON-REBATED DOOR LEAF (extra charge)

- » edge without rebate **fig. 2**
- » sockets for 2 hidden concealed Estetic 80 hinges (non-rebated door frames are equipped with hinges)
- » magnetic lock for simple key, for bathroom lock, for cylinder lock or economic lock

SLIDING SYSTEM DOOR LEAF

- » edge without rebate **fig. 2**
- » socket for hook lock and/or for handles

NOTE: It is required to use together with EMENA rebated door leaf model door frames equipped with 3 hinges. Left door unit is mirror reflection of the right door leaf unit.

OPTIONS AVAILABLE WITH EXTRA CHARGE

- » steel ventilation sleeves
- » plastic ventilation sleeves
- » non-rebated door leaf
- » door leaf „90” and „100”
- » ventilation undercut
- » cover-up strip for double leaf non-rebated door
- » double leaf door leaf price x2
- » **NOTE:** third hinge Estetic 80 for non-rebated doors (additional payment is added to the price of the door frame)

fig. 1



fig. 2



STANDARD OPTIONS

- » stiles and rails made of MDF
- » glass pane MAT DRE 4 mm thick

OPTIONS WITHOUT ADDITIONAL CHARGE

- » glass pane DECORMAT BROWN, DECORMAT GRAPHITE and transparent glass pane
- » holes for ventilation sleeves

OPTIONS AVAILABLE WITH EXTRA CHARGE

- » steel ventilation sleeves
- » plastic ventilation sleeves
- » non-rebated door leaf
- » door leaf „90” and „100”
- » ventilation undercut
- » cover-up strip for double leaf non-rebated door
- » double leaf door leaf price x2
- » **NOTE:** third hinge Estetic 80 for non-rebated doors (additional payment is added to the price of the door frame)

REBATED DOOR LEAF

- » straight edge **fig. 1**
- » 3 silver screw-in pivot hinges
- » single-point mortise lock for simple key, for bathroom lock, for cylinder lock or economic lock

NON-REBATED DOOR LEAF (extra charge)

- » edge without rebate **fig. 2**
- » sockets for 2 hidden concealed Estetic 80 hinges (non-rebated door frames are equipped with hinges)
- » magnetic lock for simple key, for bathroom lock, for cylinder lock or economic lock

SLIDING SYSTEM DOOR LEAF

- » edge without rebate **fig. 2**
- » socket for hook lock and/or for handles

fig. 1

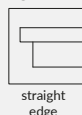
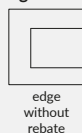

fig. 2



NOTE: It is required to use together with ENA rebated door leaf model door frames equipped with 3 hinges.



Decor DRE-Cell	white (structure)	white mat	white pine	siberian elm	sand oak	bleached oak textured	ash	golden oak textured	dark walnut textured	gray oak textured***	tabac elm	anthracite elm	dark wenge
	caramel walnut	vintage oak	gray textured	black textured									
Decor 3D	grand oak	elm	american walnut	ebony	polish oak 3D								

*** Decor available only in horizontal wood grain

STANDARD OPTIONS

- » stiles and rails made of MDF
- » glass pane MAT DRE 4 mm thick

OPTIONS WITHOUT ADDITIONAL CHARGE

- » glass pane DECORMAT BROWN, DECORMAT GRAPHITE and transparent glass pane
- » holes for ventilation sleeves

OPTIONS AVAILABLE WITH EXTRA CHARGE

- » steel ventilation sleeves
- » plastic ventilation sleeves
- » non-rebated door leaf
- » door leaf „90” and „100”
- » ventilation undercut
- » cover-up strip for double leaf non-rebated door
- » double leaf door leaf price x2
- » **NOTE:** third hinge Estetic 80 for non-rebated doors (additional payment is added to the price of the door frame)

REBATED DOOR LEAF

- » straight edge **fig. 1**
- » 3 silver screw-in pivot hinges
- » single-point mortise lock for simple key, for bathroom lock, for cylinder lock or economic lock

NON-REBATED DOOR LEAF (extra charge)

- » edge without rebate **fig. 2**
- » sockets for 2 hidden concealed Estetic 80 hinges (non-rebated door frames are equipped with hinges)
- » magnetic lock for simple key, for bathroom lock, for cylinder lock or economic lock

SLIDING SYSTEM DOOR LEAF

- » edge without rebate **fig. 2**
- » socket for hook lock and/or for handles

fig. 1



edge
fixed door
frame

fig. 2



edge
without
rebate

NOTE: It is required to use together with VERANO rebated door leaf model door frames equipped with 3 hinges.

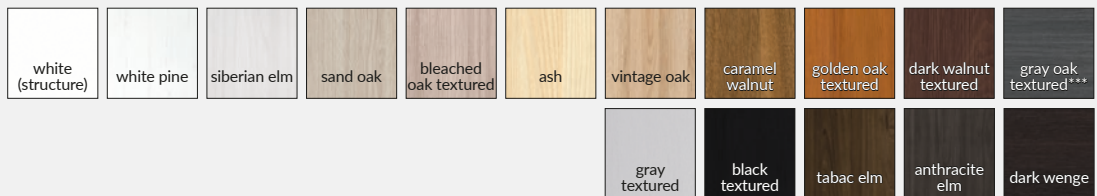

Decor
DRE-Cell

*** Decor available only in horizontal wood grain

STANDARD OPTIONS

- » stiles and rails made of MDF
- » glass pane MAT DRE 4 mm thick
- » profiled 19mm MDF panels

OPTIONS WITHOUT ADDITIONAL CHARGE

- » glass pane DECORMAT BROWN, DECORMAT GRAPHITE and transparent glass pane
- » holes for ventilation sleeves

OPTIONS AVAILABLE WITH EXTRA CHARGE

- » steel ventilation sleeves
- » plastic ventilation sleeves
- » non-rebated door leaf
- » door leaf „90” and „100”
- » ventilation undercut
- » cover-up strip for double leaf non-rebated door
- » double leaf door leaf price x2
- » **NOTE:** third hinge Estetic 80 for non-rebated doors (additional payment is added to the price of the door frame)

REBATED DOOR LEAF

- » straight edge **fig. 1**
- » 3 silver screw-in pivot hinges
- » single-point mortise lock for simple key, for bathroom lock, for cylinder lock or economic lock

NON-REBATED DOOR LEAF (extra charge)

- » edge without rebate **fig. 2**
- » sockets for 2 hidden concealed Estetic 80 hinges (non-rebated door frames are equipped with hinges)
- » magnetic lock for simple key, for bathroom lock, for cylinder lock or economic lock

SLIDING SYSTEM DOOR LEAF

- » edge without rebate **fig. 2**
- » socket for hook lock and/or for handles

fig. 1



fig. 2



NOTE: It is required to use together with TREVI rebated door leaf model door frames equipped with 3 hinges. Left door unit is mirror reflection of the right door leaf unit, refers to TREVI 1-2.



Decor
DRE-Cell

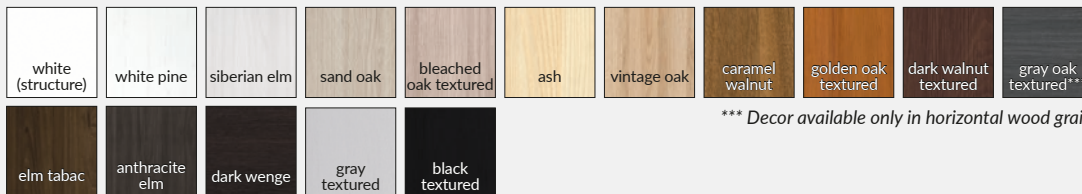

STANDARD OPTIONS

- » stiles and rails made of MDF
- » glass pane MAT DRE 4 mm thick

OPTIONS WITHOUT ADDITIONAL CHARGE

- » glass pane DECORMAT BROWN, DECORMAT GRAPHITE and transparent glass pane
- » holes for ventilation sleeves

REBATED DOOR LEAF

- » straight edge **fig. 1**
- » 3 silver screw-in pivot hinges
- » single-point mortise lock for simple key, for bathroom lock, for cylinder lock or economic lock

NON-REBATED DOOR LEAF (extra charge)

- » edge without rebate **fig. 2**
- » sockets for 2 hidden concealed Estetic 80 hinges (non-rebated door frames are equipped with hinges)
- » magnetic lock for simple key, for bathroom lock, for cylinder lock or economic lock

SLIDING SYSTEM DOOR LEAF

- » edge without rebate **fig. 2**
- » socket for hook lock and/or for handles

NOTE: It is required to use together with TRIESTA rebated door leaf model door frames equipped with 3 hinges. Left door unit is mirror reflection of the right door leaf unit.

OPTIONS AVAILABLE WITH EXTRA CHARGE

- » steel ventilation sleeves
- » plastic ventilation sleeves
- » non-rebated door leaf
- » door leaf „90” and „100”
- » ventilation undercut
- » cover-up strip for double leaf non-rebated door
- » double leaf door leaf price x2
- » **NOTE:** third hinge Estetic 80 for non-rebated doors (additional payment is added to the price of the door frame)

fig. 1



fig. 2

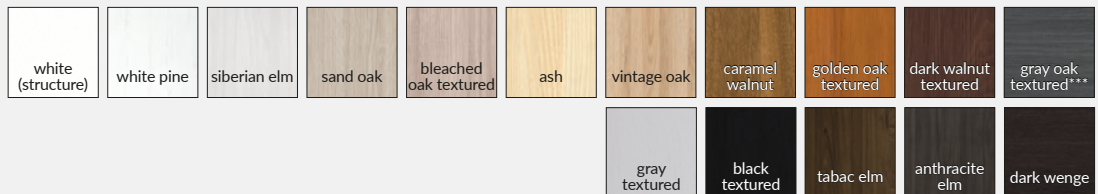

Decor
DRE-Cell

*** Decor available only in horizontal wood grain



SOLTE 3 - white mat

Decor DRE-Cell	white (structure)	white mat	white pine	siberian elm	sand oak	bleached oak textured	ash	vintage oak	caramel walnut	golden oak textured	dark walnut textured	gray oak textured***	tabac elm
	anthracite elm	dark wenge	gray textured	black textured									
Decor 3D	grand oak	elm	american walnut	ebony	polish oak 3D								

*** Decor available only in horizontal wood grain

STANDARD OPTIONS

- » stiles and rails made of MDF
- » glass pane MAT DRE 4 mm thick (SOLTE 2 - 3)
- » flat panel insert (SOLTE 1 - 2)

OPTIONS WITHOUT ADDITIONAL CHARGE

- » glass pane DECORMAT BROWN, DECORMAT GRAPHITE and transparent glass pane
- » holes for ventilation sleeves

OPTIONS AVAILABLE WITH EXTRA CHARGE

- » steel ventilation sleeves
- » plastic ventilation sleeves
- » non-rebated door leaf
- » door leaf „90” and „100”
- » ventilation undercut
- » cover-up strip for double leaf non-rebated door
- » double leaf door leaf price x2
- » **NOTE:** third hinge Estetic 80 for non-rebated doors (additional payment is added to the price of the door frame)

REBATED DOOR LEAF

- » straight edge **fig. 1**
- » 3 silver screw-in pivot hinges
- » single-point mortise lock for simple key, for bathroom lock, for cylinder lock or economic lock

NON-REBATED DOOR LEAF (extra charge)

- » edge without rebate **fig. 2**
- » sockets for 2 hidden concealed Estetic 80 hinges (non-rebated door frames are equipped with hinges)
- » magnetic lock for simple key, for bathroom lock, for cylinder lock or economic lock

SLIDING SYSTEM DOOR LEAF

- » edge without rebate **fig. 2**
- » socket for hook lock and/or for handles

NOTE: There is possibility to make rebated "40" side panels.
NOTE: It is required to use together with SOLTE rebated door leaf model door frames equipped with 3 hinges.

fig. 1

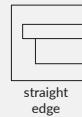
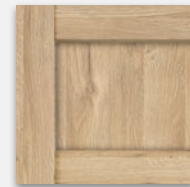

fig. 2



SOLTE panel



SOLTE 1

SOLTE 2

SOLTE 3



REVA 1 - vintage oak

Decor DRE-Cell	white (structure)	white mat	white pine	siberian elm	sand oak	bleached oak textured	ash	vintage oak	caramel walnut	golden oak textured	dark walnut textured	gray oak textured***	tabac elm
	anthracite elm	dark wenge	gray textured	black textured									
Decor 3D	grand oak	elm	american walnut	ebony	polish oak 3D								

*** Decor available only in horizontal wood grain

STANDARD OPTIONS

- » stiles and rails made of MDF
- » glass pane MAT DRE 4 mm thick
- » flat inserts (REVA 5-7)

OPTIONS WITHOUT ADDITIONAL CHARGE

- » glass pane DECORMAT BROWN, DECORMAT GRAPHITE and transparent glass pane
- » holes for ventilation sleeves

OPTIONS AVAILABLE WITH EXTRA CHARGE

- » steel ventilation sleeves
- » plastic ventilation sleeves
- » non-rebated door leaf
- » door leaf „90” and „100”
- » ventilation undercut
- » cover-up strip for double leaf non-rebated door
- » double leaf door leaf price x2
- » **NOTE:** third hinge Estetic 80 for non-rebated doors (additional payment is added to the price of the door frame)

REBATED DOOR LEAF

- » straight edge **fig. 1**
- » 3 silver screw-in pivot hinges
- » single-point mortise lock for simple key, for bathroom lock, for cylinder lock or economic lock

NON-REBATED DOOR LEAF (extra charge)

- » edge without rebate **fig. 2**
- » sockets for 2 hidden concealed Estetic 80 hinges (non-rebated door frames are equipped with hinges)
- » magnetic lock for simple key, for bathroom lock, for cylinder lock or economic lock

SLIDING SYSTEM DOOR LEAF

- » edge without rebate **fig. 2**
- » socket for hook lock and/or for handles

NOTE: There is possibility to make rebated "40" side panels.

NOTE: It is required to use together with REVA rebated door leaf model door frames equipped with 3 hinges.

fig. 1

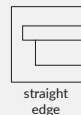









fig. 2





NESTOR 10 white pine

Decor DRE-Cell	 white mat	 white pine	 ash	 sand oak	 vintage oak	 anthracite elm	 dark wenge
	Decor 3D	 polish oak 3D					

FREE MONDO DOOR HANDLE WITH BACKPLATE

(available only with rebated and non-rebated door leaf
in NESTOR and ELSA collections in DRE-CELL and 3D decor)
colour satin nickel



STANDARD OPTIONS

- » stiles and rails made of MDF
- » glass pane MAT DRE 4 mm thick
- » profiled 19mm MDF panels

OPTIONS WITHOUT ADDITIONAL CHARGE

- » glass pane DECORMAT BROWN, DECORMAT GRAPHITE and transparent glass pane
- » holes for ventilation sleeves

OPTIONS AVAILABLE WITH EXTRA CHARGE

- » steel ventilation sleeves
- » plastic ventilation sleeves
- » non-rebated door leaf
- » door leaf „90” and „100”
- » ventilation undercut
- » cover-up strip for double leaf non-rebated door
- » double leaf door leaf price x2
- » **NOTE:** third hinge Estetic 80 for non-rebated doors (additional payment is added to the price of the door frame)

REBATED DOOR LEAF

- » straight edge **fig. 1**
- » 3 silver screw-in pivot hinges
- » single-point mortise lock for simple key, for bathroom lock, for cylinder lock or economic lock

NON-REBATED DOOR LEAF (EXTRA CHARGE)

- » edge without rebate **fig. 2**
- » sockets for 2 hidden concealed Estetic 80 hinges (non-rebated door frames are equipped with hinges)
- » magnetic lock for simple key, for bathroom lock, for cylinder lock or economic lock

SLIDING SYSTEM DOOR LEAF

- » edge without rebate **fig. 2**
- » socket for hook lock and/or for handles

fig. 1



fig. 2



NOTE: It is required to use together with NESTOR rebated door leaf model door frames equipped with 3 hinges.



panel
NESTOR



AURI white mat

Decor DRE-Cell	white (structure)	white mat	white pine	siberian elm	sand oak	bleached oak textured	ash	vintage oak	caramel walnut	golden oak textured	dark walnut textured	gray oak textured***	tabac elm
	anthracite elm	dark wenge	gray textured	black textured									
Decor 3D	grand oak	elm	american walnut	ebony	polish oak 3D								

*** Decor available only in horizontal wood grain

STANDARD OPTIONS

- » stiles and rails made of MDF
- » glass pane MAT DRE 4 mm thick
- » flat inserts (AURI 6-8)

OPTIONS WITHOUT ADDITIONAL CHARGE

- » glass pane DECORMAT BROWN, DECORMAT GRAPHITE and transparent glass pane
- » holes for ventilation sleeves

OPTIONS AVAILABLE WITH EXTRA CHARGE

- » steel ventilation sleeves
- » plastic ventilation sleeves
- » non-rebated door leaf
- » door leaf „90” and „100”
- » ventilation undercut
- » cover-up strip for double leaf non-rebated door
- » double leaf door leaf price x2
- » **NOTE:** third hinge Estetic 80 for non-rebated doors (additional payment is added to the price of the door frame)

REBATED DOOR LEAF

- » straight edge **fig. 1**
- » 3 silver screw-in pivot hinges
- » single-point mortise lock for simple key, for bathroom lock, for cylinder lock or economic lock

NON-REBATED DOOR LEAF (extra charge)

- » edge without rebate **fig. 2**
- » sockets for 2 hidden concealed Estetic 80 hinges (non-rebated door frames are equipped with hinges)
- » magnetic lock for simple key, for bathroom lock, for cylinder lock or economic lock

SLIDING SYSTEM DOOR LEAF

- » edge without rebate **fig. 2**
- » socket for hook lock and/or for handles

NOTE: There is possibility to make rebated "40" side panels. It is required to use together with AURI rebated door leaf model door frames equipped with 3 hinges.

fig. 1

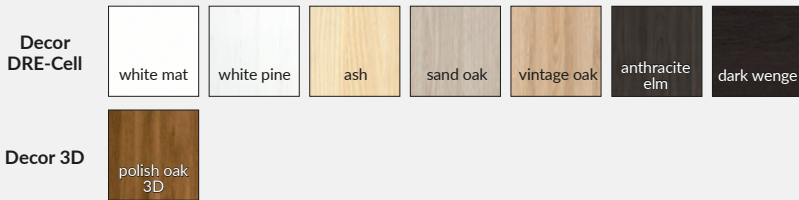

fig. 2





ELSA A3 and ELSA ash



FREE MONDO DOOR HANDLE WITH BACKPLATE
 (available only with rebated and non-rebated door leaf
 in NESTOR and ELSA collections in DRE-CELL and 3D decor)
 colour satin nickel

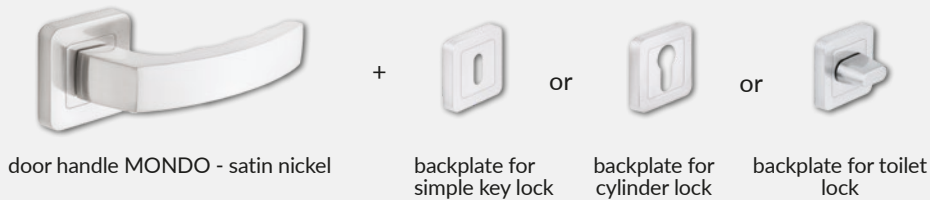

STANDARD OPTIONS

- » stiles and rails made of MDF
- » glass pane MAT DRE 4 mm thick
- » flat panel insert (ELSA A), profiled 19 mm MDF panels (ELSA B)

OPTIONS WITHOUT ADDITIONAL CHARGE

- » glass pane DECORMAT BROWN, DECORMAT GRAPHITE and transparent glass pane
- » holes for ventilation sleeves

OPTIONS AVAILABLE WITH EXTRA CHARGE

- » steel ventilation sleeves
- » plastic ventilation sleeves
- » non-rebated door leaf
- » door leaf „90” and „100”
- » ventilation undercut
- » cover-up strip for double leaf non-rebated door
- » double leaf door leaf price x2
- » **NOTE:** third hinge Estetic 80 for non-rebated doors (additional payment is added to the price of the door frame)

REBATED DOOR LEAF

- » straight edge **fig. 1**
- » 3 silver screw-in pivot hinges
- » single-point mortise lock for simple key, for bathroom lock, for cylinder lock or economic lock

NON-REBATED DOOR LEAF (extra charge)

- » edge without rebate **fig. 2**
- » sockets for 2 hidden concealed Estetic 80 hinges (non-rebated door frames are equipped with hinges)
- » magnetic lock for simple key, for bathroom lock, for cylinder lock or economic lock

SLIDING SYSTEM DOOR LEAF

- » edge without rebate **fig. 2**
- » socket for hook lock and/or for handles

NOTE: There is possibility to make rebated "40" side panels. It is required to use together with EMENA rebated door leaf model door frames equipped with 3 hinges.

fig. 1

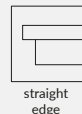

straight edge

fig. 2



edge without rebate

ELSA collection is divided into A and B:
A - flat panel insert in door leaf colour
B - 19 mm convex panel insert in door leaf colour



cross-section of ELSA A



cross-section of ELSA B



STANDARD OPTIONS

- » stiles and rails made of MDF
- » glass pane MAT DRE 4 mm thick
- » flat panel insert coated with silver laminate (FOSCA 1-3) or in door leaf colour (FOSCA 4-6)

OPTION WITHOUT ADDITIONAL CHARGE

- » glass pane DECORMAT BROWN, DECORMAT GRAPHITE and transparent glass pane
- » holes for ventilation sleeves

OPTIONS AVAILABLE WITH EXTRA CHARGE

- » steel ventilation sleeves
- » plastic ventilation sleeves
- » non-rebated door leaf
- » door leaf „90” and „100”
- » ventilation undercut
- » cover-up strip for double leaf non-rebated door
- » double leaf door leaf price x2
- » **NOTE:** third hinge Estetic 80 for non-rebated doors (additional payment is added to the price of the door frame)

REBATED DOOR LEAF

- » straight edge **fig. 1**
- » 3 silver screw-in pivot hinges
- » single-point mortise lock for simple key, for bathroom lock, for cylinder lock or economic lock

NON-REBATED DOOR LEAF (extra charge)

- » edge without rebate **fig. 2**
- » sockets for 2 hidden concealed Estetic 80 hinges (non-rebated door frames are equipped with hinges)
- » magnetic lock for simple key, for bathroom lock, for cylinder lock or economic lock

SLIDING SYSTEM DOOR LEAF

- » edge without rebate **fig. 2**
- » socket for hook lock and/or for handles

NOTE: There is possibility to make rebated „40” side panels.

NOTE: It is required to use together with FOSCA rebated door leaf model door frames equipped with 3 hinges.

fig. 1



straight edge

fig. 2



edge without rebate



FOSCA 1-3
(4mm HDF insert coated with silver laminate)

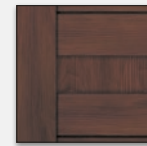

FOSCA 4-6
(4mm HDF insert coated in door leaf colour)



FOSCA
(5 glass panes)

FOSCA 1
(3 glass panes, 2 HDF panels)

FOSCA 2
(1 glass pane, 4 HDF panels)

FOSCA 3
(5 HDF panels)

FOSCA 4
(3 glass panes, 2 HDF panels)

FOSCA 5
(1 glass pane, 4 HDF panels)

FOSCA 6
(5 HDF panels)

Decor
DRE-Cell

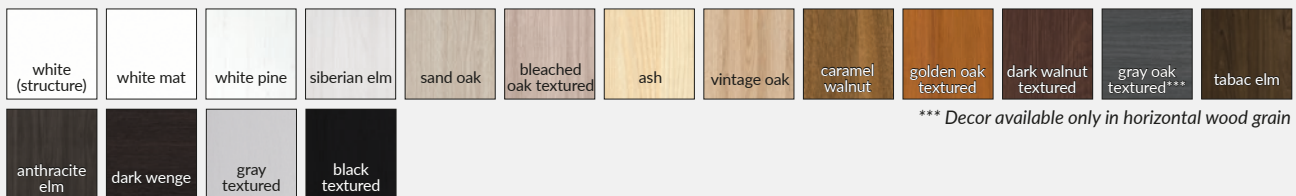

*** Decor available only in horizontal wood grain

Decor 3D



STANDARD OPTIONS

- » stiles and rails made of MDF
- » glass pane MAT DRE 4 mm thick

OPTION WITHOUT ADDITIONAL CHARGE

- » glass pane DECORMAT BROWN, DECORMAT GRAPHITE and transparent glass pane
- » holes for ventilation sleeves

REBATED DOOR LEAF

- » straight edge **fig. 1**
- » 3 silver screw-in pivot hinges
- » single-point mortise lock for simple key, for bathroom lock, for cylinder lock or economic lock

NON-REBATED DOOR LEAF (extra charge)

- » edge without rebate **fig. 2**
- » sockets for 2 hidden concealed Estetic 80 hinges (non-rebated door frames are equipped with hinges)
- » magnetic lock for simple key, for bathroom lock, for cylinder lock or economic lock

SLIDING SYSTEM DOOR LEAF

- » edge without rebate **fig. 2**
- » socket for hook lock and/or for handles

NOTE: There is possibility to make rebated „40” side panels.
NOTE: It is required to use together with PREMIUM rebated door leaf model door frames equipped with 3 hinges.

OPTIONS AVAILABLE WITH EXTRA CHARGE

- » steel ventilation sleeves
- » plastic ventilation sleeves
- » non-rebated door leaf
- » door leaf „90” and „100”
- » ventilation undercut
- » cover-up strip for double leaf non-rebated door
- » double leaf door leaf price x2
- » **NOTE:** third hinge Estetic 80 for non-rebated doors (additional payment is added to the price of the door frame)

fig. 1



edge fixed door frame

fig. 2



edge without rebate

In PREMIUM 12 and 13 models, from the top edge there are used two glass panes.



PREMIUM, PREMIUM 1-3 (4 mm glass pane)

* PREMIUM 4-7, 12 (4 mm HDF inserts in door leaf colour)

** PREMIUM 8-11, 13 (4 mm HDF inserts, coated with a silver laminate)



PREMIUM PREMIUM 4* PREMIUM 8**

PREMIUM 1 PREMIUM 5* PREMIUM 9**

PREMIUM 2 PREMIUM 6* PREMIUM 10**

PREMIUM 3 PREMIUM 7* PREMIUM 11**

PREMIUM 12 2 glass panes, 6 inserts in the colour of the door leaf

PREMIUM 13 2 glass panes, 6 inserts coated with a silver laminate

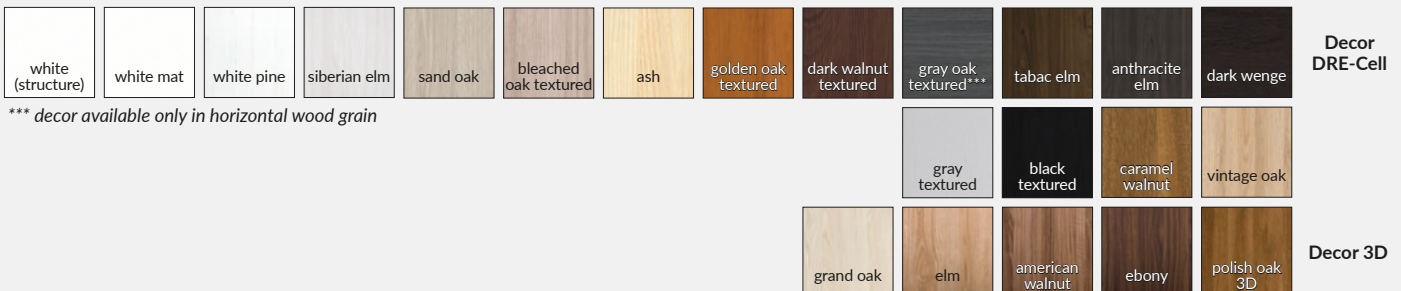



PIANO - Polish oak 3D

Decor DRE-Cell	white (structure)	white mat	white pine	siberian elm	sand oak	bleached oak textured	ash	vintage oak	caramel walnut	golden oak textured	dark walnut textured	gray oak textured***	tabac elm
	elm anthracite	dark wenge	gray textured	black textured									
Decor 3D	grand oak	elm	american walnut	ebony	polish oak 3D								

*** Decor available only in horizontal wood grain

STANDARD OPTIONS

- » stiles and rails made of MDF
- » glass pane MAT DRE 4 mm thick
- » 16 mm convex panel (PIANO 1-2, PIANO 5-6)
or 19 mm convex panel (PIANO 9-12)

OPTION WITHOUT ADDITIONAL CHARGE

- » glass pane DECORMAT BROWN, DECORMAT GRAPHITE and transparent glass pane
- » holes for ventilation sleeves

OPTIONS AVAILABLE WITH EXTRA CHARGE

- » steel ventilation sleeves
- » plastic ventilation sleeves
- » non-rebated door leaf
- » door leaf „90” and „100”
- » ventilation undercut
- » cover-up strip for double leaf non-rebated door
- » double leaf door leaf price x2
- » **NOTE:** third hinge Estetic 80 for non-rebated doors (additional payment is added to the price of the door frame)

REBATED DOOR LEAF

- » straight edge **fig. 1**
- » 3 silver screw-in pivot hinges
- » single-point mortise lock for simple key, for bathroom lock, for cylinder lock or economic lock

NON-REBATED DOOR LEAF (extra charge)

- » edge without rebate **fig. 2**
- » sockets for 2 hidden concealed Estetic 80 hinges (non-rebated door frames are equipped with hinges)
- » magnetic lock for simple key, for bathroom lock, for cylinder lock or economic lock

SLIDING SYSTEM DOOR LEAF

- » edge without rebate **fig. 2**
- » socket for hook lock and/or for handles

NOTE: There is possibility to make rebated „40” side panels.
It is required to use together with EMENA rebated door leaf model door frames equipped with 3 hinges.

fig. 1



fig. 2



panel PIANO 9-12





SCALA - white matt

Decor DRE-Cell	white (structure)	white mat	white pine	siberian elm	sand oak	bleached oak textured	ash	vintage oak	caramel walnut	golden oak textured	dark walnut textured	gray oak textured***	tabac elm
	anthracite elm	dark wenge	gray textured	black textured	*** decor available only in horizontal wood grain								
Decor 3D	grand oak	elm	american walnut	ebony	polish oak 3D								

FREE STYLISH DOOR HANDLE WITH BACKPLATE

(available only rebated and non-rebated door leaf in SCALA collection in DRE-Cell and 3D decor)
colour satin nickel



STANDARD OPTIONS

- » stiles and rails made of MDF
- » glass pane MAT DRE 4 mm thick
- » flat panel insert (SCALA A), 19 mm profiled MDF panels (SCALA B)

OPTIONS WITHOUT ADDITIONAL CHARGE

- » glass pane DECORMAT BROWN, DECORMAT GRAPHITE and transparent glass pane
- » holes for ventilation sleeves

OPTIONS AVAILABLE WITH EXTRA CHARGE

- » steel ventilation sleeves
- » plastic ventilation sleeves
- » non-rebated door leaf
- » door leaf „90” and „100”
- » ventilation undercut
- » cover-up strip for double leaf non-rebated door
- » double leaf door leaf price x2
- » **NOTE:** third hinge Estetic 80 for non-rebated doors (additional payment is added to the price of the door frame)

REBATED DOOR LEAF

- » straight edge **fig. 1**
- » 3 silver screw-in pivot hinges
- » single-point mortise lock for simple key, for bathroom lock, for cylinder lock or economic lock

NON-REBATED DOOR LEAF (extra charge)

- » edge without rebate **fig. 2**
- » sockets for 2 hidden concealed Estetic 80 hinges (non-rebated door frames are equipped with hinges)
- » magnetic lock for simple key, for bathroom lock, for cylinder lock or economic lock

SLIDING SYSTEM DOOR LEAF

- » edge without rebate **fig. 2**
- » socket for hook lock and/or for handles

NOTE: There is possibility to make rebated "40" side panels. It is required to use together with EMENA rebated door leaf model door frames equipped with 3 hinges.

SCALA collection is divided into A and B:
A - flat panel insert in door leaf colour
B - convex panel insert in door leaf colour

fig. 1



fig. 2



panel SCALA A, A1-A7



panel SCALA B, B1-B7

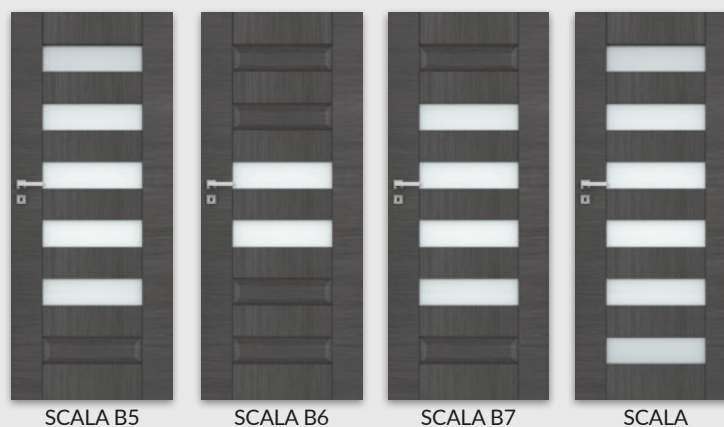



SINCO A - bleached elm

Finish veneer

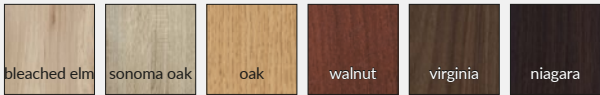

STANDARD OPTIONS

- » stiles and rails made of MDF
- » glass pane MAT DRE 4 mm thick
- » flat panels

OPTIONS WITHOUT ADDITIONAL CHARGE

- » holes for ventilation sleeves

OPTIONS AVAILABLE WITH EXTRA CHARGE

- » steel ventilation sleeves
- » plastic ventilation sleeves
- » door leaf „90” and „100”
- » ventilation undercut

NOTE: It is required to use together with SINCO rebated door leaf model door frames equipped with 3 hinges.

REBATED DOOR LEAF

- » straight edge **fig. 1**
- » 3 silver screw-in pivot hinges
- » single-point mortise lock for simple key, for bathroom lock, for cylinder lock or economic lock

fig. 1

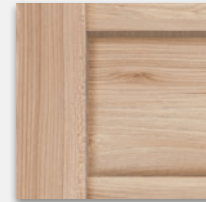
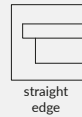

panel SINCO





VERSO - white pine

Decor
DRE-Cell



STANDARD OPTIONS

- » stiles and rails made of MDF
- » glass pane MAT DRE 4 mm thick

OPTIONS WITHOUT ADDITIONAL CHARGE

- » glass pane DECORMAT BROWN, DECORMAT GRAPHITE and transparent glass pane
- » holes for ventilation sleeves

OPTIONS AVAILABLE WITH EXTRA CHARGE

- » steel ventilation sleeves
- » plastic ventilation sleeves
- » non-rebated door leaf
- » door leaf „90” and „100”
- » ventilation undercut
- » cover-up strip for double leaf non-rebated door
- » double leaf door leaf price x2
- » **NOTE:** third hinge Estetic 80 for non-rebated doors (additional payment is added to the price of the door frame)

REBATED DOOR LEAF

- » straight edge **fig. 1**
- » 3 silver screw-in pivot hinges
- » single-point mortise lock for simple key, for bathroom lock, for cylinder lock or economic lock

NON-REBATED DOOR LEAF (extra charge)

- » edge without rebate **fig. 2**
- » sockets for 2 hidden concealed Estetic 80 hinges (non-rebated door frames are equipped with hinges)
- » magnetic lock for simple key, for bathroom lock, for cylinder lock or economic lock

SLIDING SYSTEM DOOR LEAF

- » edge without rebate **fig. 2**
- » socket for hook lock and/or for handles

fig. 1

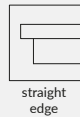
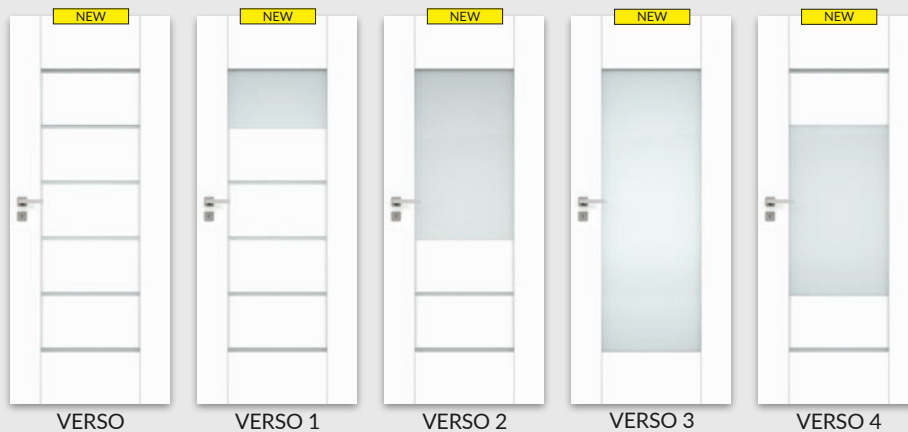

fig. 2





VETRO A5 white pine

Decor DRE-Cell	white (structure)	white mat	white pine	siberian elm	sand oak	bleached oak textured	ash	vintage oak	caramel walnut	golden oak textured	dark walnut textured	gray oak textured***	tabac elm
	anthracite elm	dark wenge	gray textured	black textured	*** Decor available only in horizontal wood grain								
Decor 3D	grand oak	elm	american walnut	ebony	polish oak 3D								

NOTE: It is possible to order non-rebated door leaf in Dre-Cell white mat colour

cross-section of stile in non-rebated door leaf

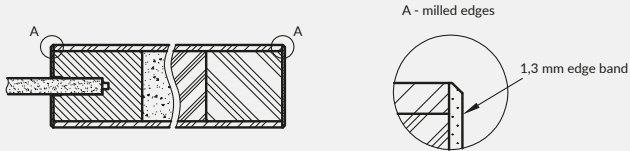

Glass panes in VETRO collection have obverse and reverse sides (important in juxtaposition of doors opening inversely). Presented horizontal cross-sections shows the arrangement of glass pane in the obverse version. When choosing a reverse version, glass pane is rotated by 180° around the vertical axis.

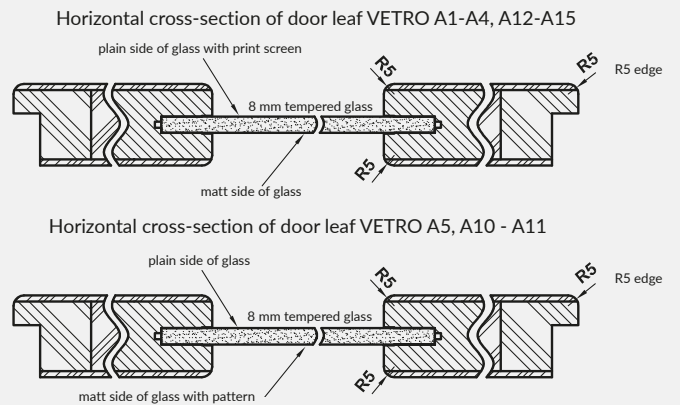

STANDARD OPTIONS

- » frame made of MDF additionally reinforced with plywood
- » core made of perforated chipboard
- » 8 mm tempered glass

OPTIONS WITHOUT ADDITIONAL CHARGE

- » there is possibility to make ventilation undercut (A)
- » door leaf with revers positioning of glass pane
- » VETRO A1 four possible types of glass pane: DECORMAT, DECORMAT BROWN, DECORMAT GRAPHITE and transparent glass

REBATED DOOR LEAF

- » R5 edge **fig. 1**
- » 3 silver screw-in pivot hinges
- » single-point mortise lock for simple key, for bathroom lock, for cylinder lock or economic lock

NON- REBATED DOOR LEAF (EXTRA CHARGE 55 PLN)

ONLY WHITE MAT

- » edge without rebate **fig. 2**
- » sockets for 2 hidden concealed Estetic 80 hinges (non-rebated door frames are equipped with hinges)
- » magnetic lock for simple key, for bathroom lock, for cylinder lock or economic lock

fig. 1

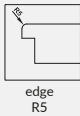

edge
R5

fig. 2

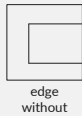

edge
without
rebate

OPTIONS AVAILABLE WITH EXTRA CHARGE - AVAILABLE ONLY IN WHITE MAT DRE-CELL DECOR

- » non-rebated door leaf
- » **NOTE:** third hinge Estetic 80 for non-rebated doors (additional payment is added to the price of the door frame)

ventilation undercut (A)

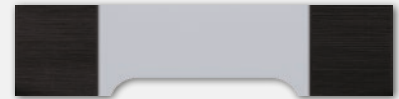

SLIDING SYSTEM DOOR LEAF

- » edge without rebate **fig. 2**
- » socket for hook lock and/or for handles

NOTE: Door leaf VETRO A in sliding version is not complementary product to sliding system hidden in the wall PA.

NOTE: There is no possibility to shorten door leaf.

NOTE: It is required to use together with VETRO rebated door leaf model door frames equipped with 3 hinges.

VETRO A - „80“-„100“ - with ventilation undercut fulfill ventilation requirements..

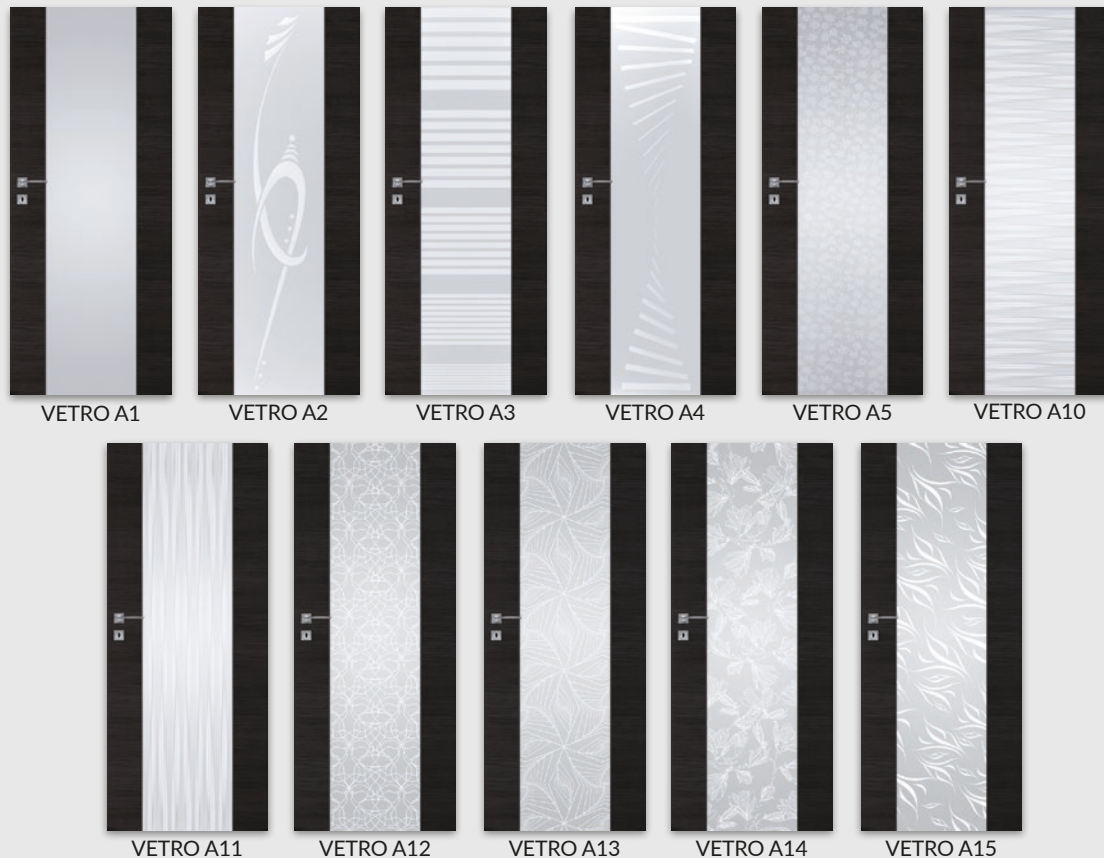



VETRO B11 - black textured

Decor DRE-Cell	white (structure)	white mat	white pine	siberian elm	sand oak	bleached oak textured	ash	vintage oak	caramel walnut	golden oak textured	dark walnut textured	gray oak textured***
	tabac elm	anthracite elm	dark wenge	gray textured	black textured							
Decor 3D	grand oak	elm	american walnut	ebony	polish oak 3D							

*** decor available only in horizontal wood grain

NOTE: It is possible to order non-rebated door leaf in Dre-Cell white mat colour

cross-section of stile in non-rebated door leaf

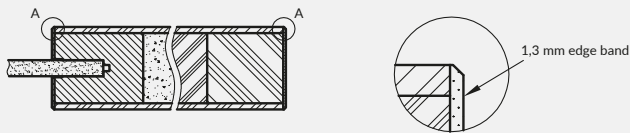

Glass panes in VETRO collection have obverse and reverse sides (important in juxtaposition of doors opening inversely). Presented horizontal cross-sections shows the arrangement of glass pane in the obverse version. When choosing a reverse version, glass pane is rotated by 180° around the vertical axis.

Horizontal cross-section of VETRO B1 - B4, B12 - B15

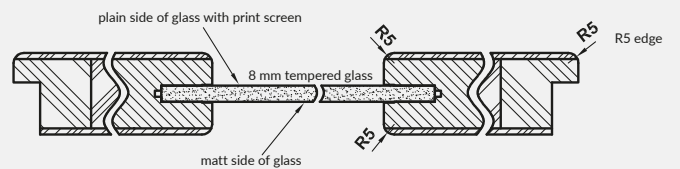

Horizontal cross-section of VETRO B5, B10-B11

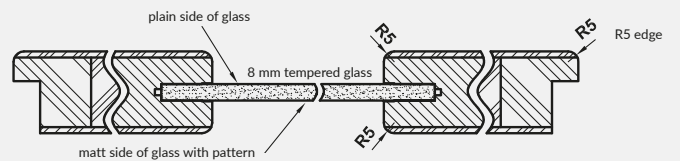

STANDARD OPTIONS

- » frame made of MDF additionally reinforced with plywood
- » core made of perforated chipboard
- » 8 mm tempered glass

OPTIONS WITHOUT ADDITIONAL CHARGE

- » there is possibility to make ventilation undercut (B)
- » VETRO B1 four possible types of glass pane: DECORMAT, DECORMAT BROWN, DECORMAT GRAPHITE and transparent glass
- » door leaf with revers positioning of glass pane

REBATED DOOR LEAF

- » R5 edge **fig. 1**
- » 3 silver screw-in pivot hinges
- » single-point mortise lock for simple key, for bathroom lock, for cylinder lock or economic lock

NON- REBATED DOOR LEAF (EXTRA CHARGE 55 PLN)

ONLY WHITE MAT

- » edge without rebate **fig. 2**
- » sockets for 2 hidden concealed Estetic 80 hinges (non-rebated door frames are equipped with hinges)
- » magnetic lock for simple key, for bathroom lock, for cylinder lock or economic lock

fig. 1



edge R5

fig. 2



edge without rebate

OPTIONS AVAILABLE WITH EXTRA CHARGE - AVAILABLE ONLY IN WHITE MAT DRE-CELL DECOR

- » non-rebated door leaf
- » **NOTE:** third hinge Estetic 80 for non-rebated doors (additional payment is added to the price of the door frame)

ventilation undercut (B)



VETRO B - doesnt fulfill ventilation requirements

SLIDING SYSTEM DOOR LEAF

- » edge without rebate **fig. 2**
- » socket for hook lock and/or for handles

NOTE: Door leaf VETRO B in sliding version with "70" width is not complementary product to sliding system hidden in the wall PA.

NOTE: There is no possibility to shorten door leaf.

NOTE: It is required to use together with VETRO rebated door leaf model door frames equipped with 3 hinges.

VETRO B - doesnt fulfill ventilation requirements.

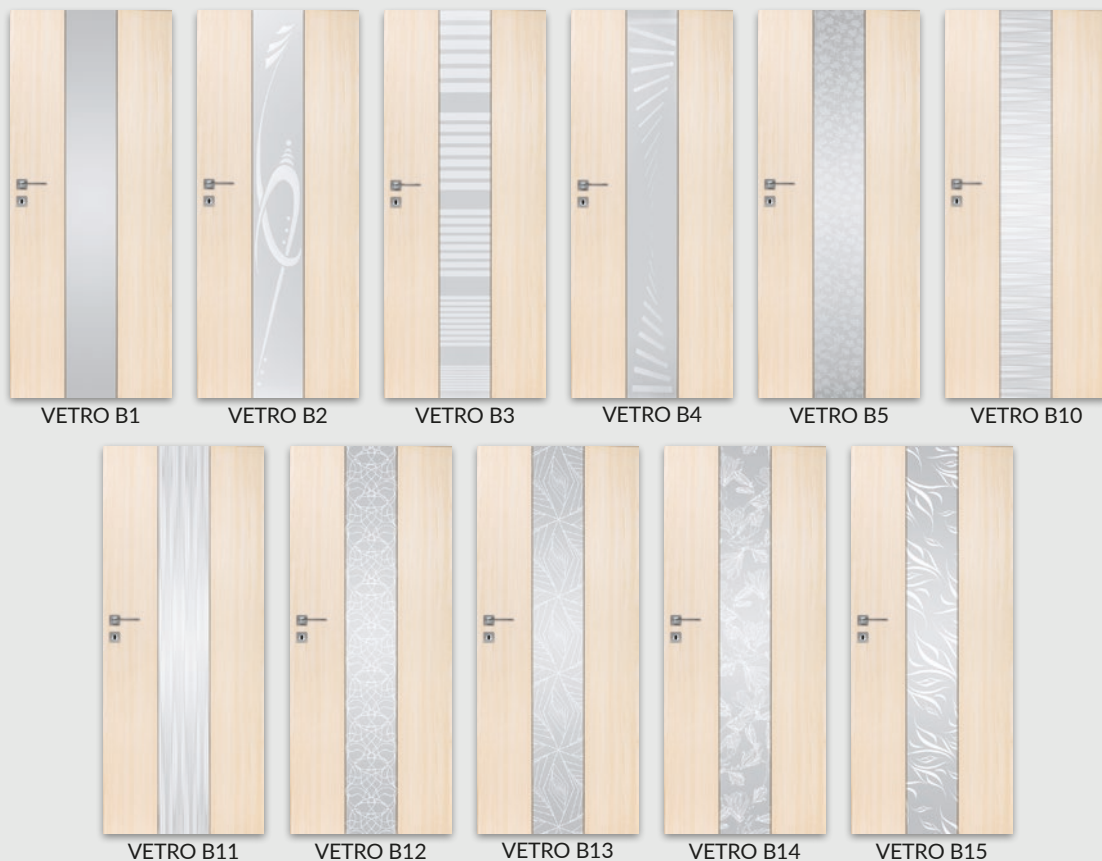



VETRO C10 - dark walnut textured

Decor
DRE-Cell

white (structure)	white pine	siberian elm	sand oak	bleached oak textured	ash	vintage oak	caramel walnut	golden oak textured	dark walnut textured	gray oak textured***
elm tabac	anthracite elm	dark wenge	gray textured	black textured						

*** Decor available only in horizontal wood grain

Glass panes in VETRO collection have obverse and reverse sides (important in juxtaposition of doors opening inversely). Presented horizontal cross-sections shows the arrangement of glass pane in the obverse version. When choosing a reverse version, glass pane is rotated by 180° around the vertical axis.

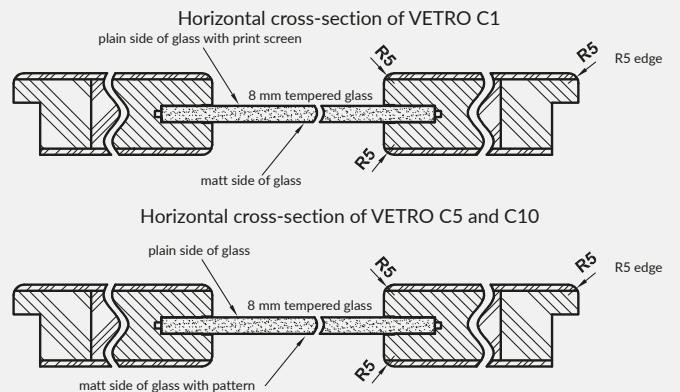

STANDARD OPTIONS

- » frame with fixed width made of MDF additionally reinforced with plywood
- » core made of perforated chipboard
- » 8 mm tempered glass with different width, dependent on width of the door leaf

OPTIONS WITHOUT ADDITIONAL CHARGE

- » there is a possibility to make ventilation undercut (C)
- » door leaf with revers positioning of glass pane

ventilation undercut (C)

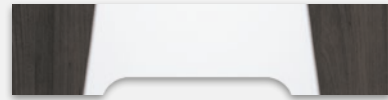

REBATED DOOR LEAF

- » R5 edge **fig. 1**
- » 3 silver screw-in pivot hinges
- » single-point mortise lock for simple key, for bathroom lock, for cylinder lock or economic lock

NOTE: There is no possibility to shorten door leaf.

It is required to use together with VETRO door leaf model door frames equipped with 3 hinges.

VETRO C - „80“-„100“ - with ventilation undercut fulfill ventilation requirements.

fig. 1



edge
R5

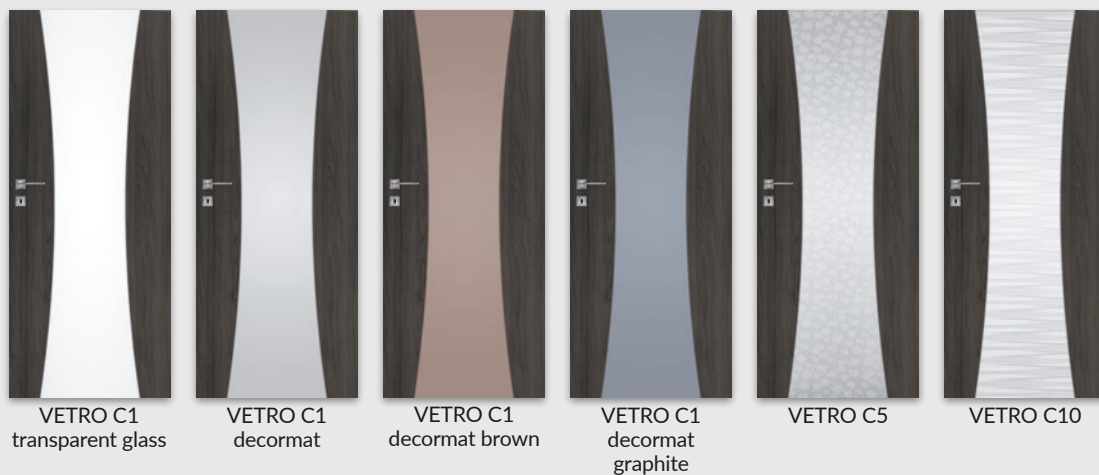



VETRO D1 - anthracite elm

Decor DRE-Cell	white (structure)	white mat	white pine	siberian elm	sand oak	bleached oak textured	ash	vintage oak	caramel walnut	golden oak textured	dark walnut textured	gray oak textured***	tabac elm
	anthracite elm	dark wenge	gray textured	black textured	*** decor available only in horizontal wood grain								
Decor 3D	grand oak	elm	american walnut	ebony	polish oak 3D								

NOTE: It is possible to order non-rebated door leaf in Dre-Cell white mat colour

Glass panes in VETRO collection have obverse and reverse sides (important in juxtaposition of doors opening inversely). Presented horizontal cross-sections shows the arrangement of glass pane in the obverse version. When choosing a reverse version, glass pane is rotated by 180° around the vertical axis.

cross-section of stile in non-rebated door leaf

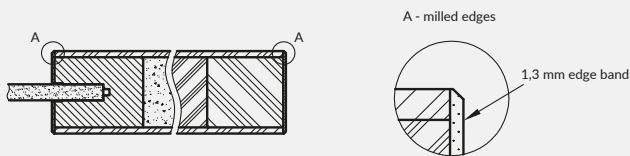

Horizontal cross-section of VETRO D1

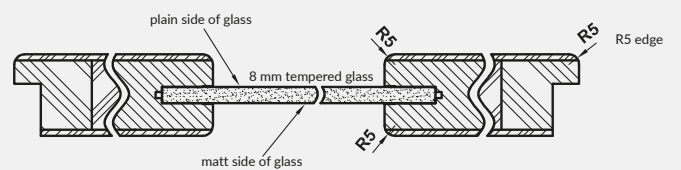

STANDARD OPTIONS

- » frame made of MDF additionally reinforced with plywood: narrow element with fixed width, wide element with different width
- » core made of perforated chipboard
- » 8 mm tempered glass with fixed width, (regardless of the door leaf width)

OPTIONS WITHOUT ADDITIONAL CHARGE

- » door leaf with revers positioning of glass pane

REBATED DOOR LEAF

- » R5 edge **fig. 1**
- » 3 silver screw-in pivot hinges
- » single-point mortise lock for simple key, for bathroom lock, for cylinder lock or economic lock

NON- REBATED DOOR LEAF (EXTRA CHARGE 55 PLN)

ONLY WHITE MAT

- » edge without rebate **fig. 2**
- » sockets for 2 hidden concealed Estetic 80 hinges (non-rebated door frames are equipped with hinges)
- » magnetic lock for simple key, for bathroom lock, for cylinder lock or economic lock

OPTIONS AVAILABLE WITH EXTRA CHARGE - AVAILABLE ONLY IN WHITE MAT DRE-CELL DECOR

- » non-rebated door leaf
- » **NOTE:** third hinge Estetic 80 for non-rebated doors (additional payment is added to the price of the door frame)

SLIDING SYSTEM DOOR LEAF

- » edge without rebate **fig. 2**
- » socket for hook lock and/or for handles

NOTE: Door leaf VETRO D in sliding version is not complementary product to sliding system hidden in the wall PA.

NOTE: There is no possibility to shorten door leaf. There is no possibility to make ventilation undercut. VETRO D - doesnt fulfill ventilation requirements. **NOTE:** It is required to use together with VETRO rebated door leaf model door frames equipped with 3 hinges.

fig. 1

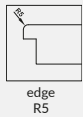

fig. 2





VETRO natura A3 - dark walnut

natural veneer



Horizontal cross-section of door leaf VETRO A1-A4, A12-A15

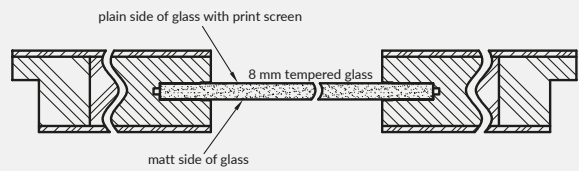

Horizontal cross-section of door leaf VETRO A5, A10 - A11

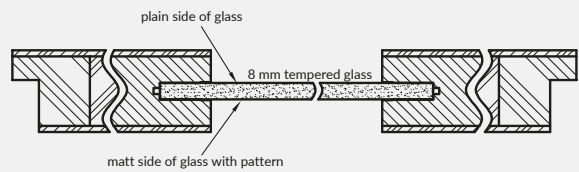

VETRO collection glass panes have obverse and reverse sides (important in juxtaposition of doors opening inversely). Presented horizontal cross-sections shows the arrangement of glass pane in the obverse version. When choosing a reverse version, glass pane is rotated by 180° around the vertical axis.

STANDARD OPTIONS

- » frame made of MDF additionally reinforced with plywood
- » core made of perforated chipboard
- » 8 mm tempered glass
- » natural veneer

OPTIONS WITHOUT ADDITIONAL CHARGE

- » there is possibility to make ventilation undercut (A)
- » door leaf with reverse positioning of glass pane
- » VETRO A1 four possible types of glass pane: DECORMAT, DECORMAT BROWN, DECORMAT GRAPHITE and transparent glass

REBATED DOOR LEAF

- » straight edge **fig. 1**
- » 3 silver screw-in pivot hinges
- » single-point mortise lock for simple key, for bathroom lock, for cylinder lock or economic lock

SLIDING SYSTEM DOOR LEAF

- » edge without rebate **fig. 2**
- » socket for hook lock and/or for handles

fig. 1

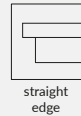

fig. 2



NOTE: Door leaf VETRO A in sliding version is not complementary product to sliding system hidden in the wall PA.

NOTE: There is no possibility to shorten door leaf. It is required to use together with VETRO door leaf model door frames equipped with 3 hinges.

VETRO A - „80“-„100“ - with ventilation undercut fulfill ventilation requirements..

NOTE: The specificity of natural veneer is a possibility of differences in wood grain and staining. These differences can not be the basis of the accepted complaint.

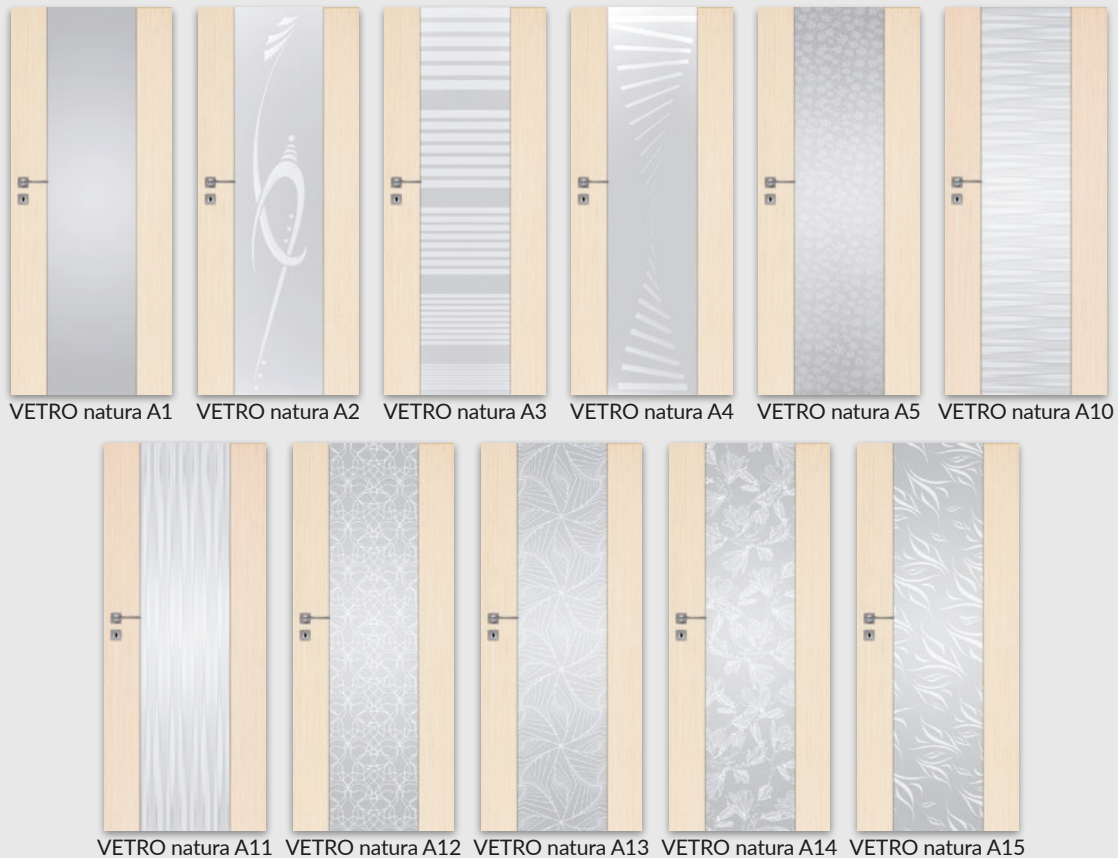



VETRO natura B11 - dark walnut

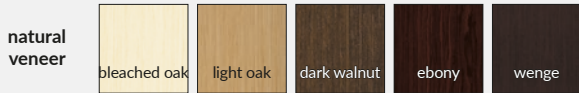

Horizontal cross-section of B1-B4, B12-B15

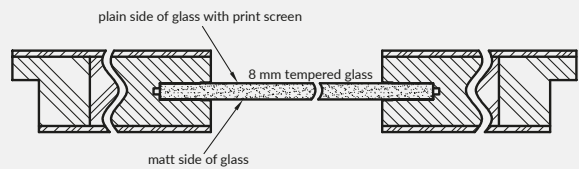

Horizontal cross-section of VETRO B5, B10-B11

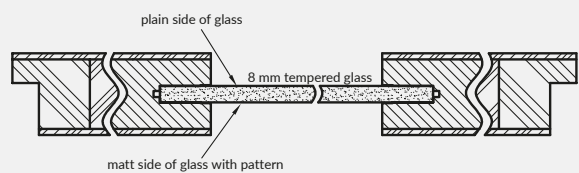

VETRO collection glass panes have obverse and reverse sides (important in juxtaposition of doors opening inversely). Presented horizontal cross-sections shows the arrangement of glass pane in the obverse version. When choosing a reverse version, glass pane is rotated by 180° around the vertical axis.

STANDARD OPTIONS

- » frame made of MDF additionally reinforced with plywood
- » core made of perforated chipboard
- » 8 mm tempered glass
- » natural veneer

OPTIONS WITHOUT ADDITIONAL CHARGE

- » there is possibility to make ventilation undercut
- » door leaf with revers positioning of glass pane
- » VETRO B1 four possible types of glass pane: DECORMAT, DECORMAT BROWN, DECORMAT GRAPHITE and transparent glass

REBATED DOOR LEAF

- » straight edge **fig. 1**
- » 3 silver screw-in pivot hinges
- » single-point mortise lock for simple key, for bathroom lock, for cylinder lock or economic lock

SLIDING SYSTEM DOOR LEAF

- » edge without rebate **fig. 2**
- » socket for hook lock and/or for handles

NOTE: Door leaf VETRO B in sliding version with "70" width is not complementary product to sliding system hidden in the wall PA.

NOTE: There is no possibility to shorten door leaf. It is required to use together with VETRO door leaf model door frames equipped with 3 hinges.

VETRO B - doesnt fulfill ventilation requirements.

NOTE: The specificity of natural veneer is a possibility of differences in wood grain and staining. These differences can not be the basis of the accepted complaint.

fig. 1

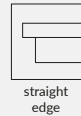

straight edge

fig. 2

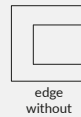

edge without rebate

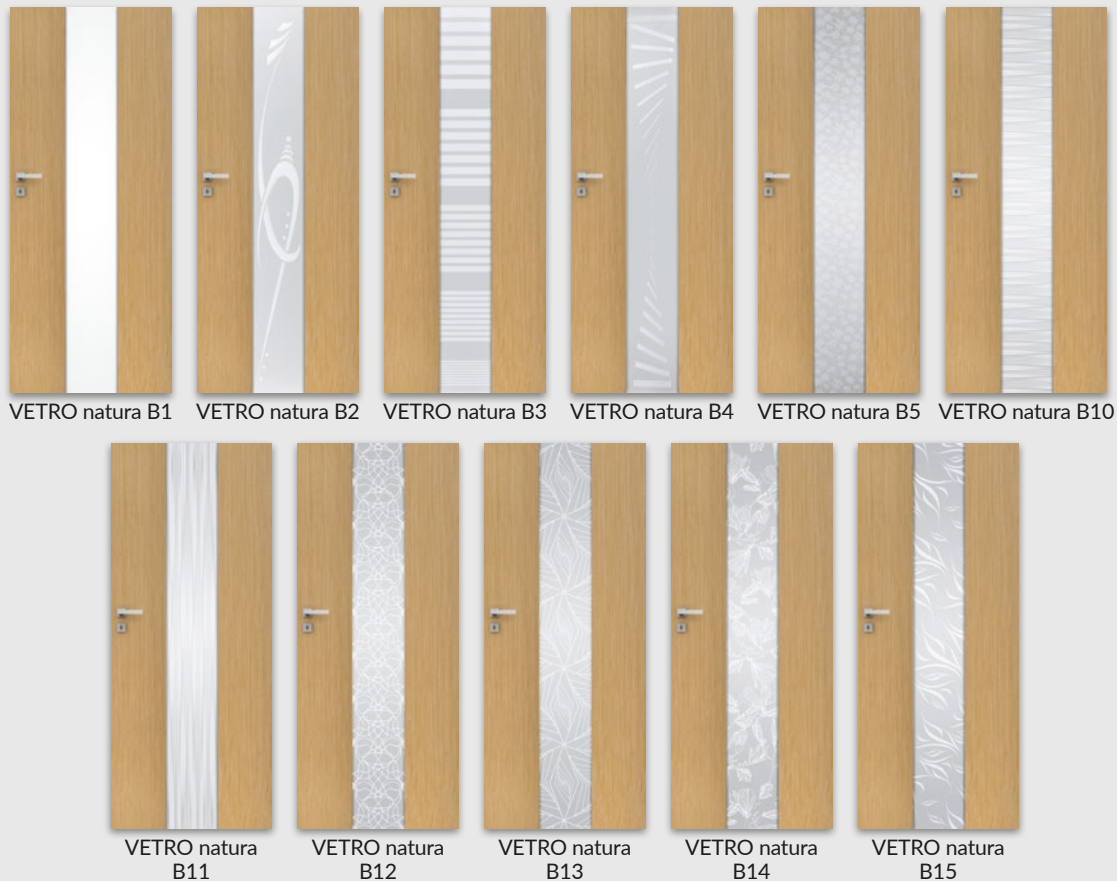

PREMIUM NATURA

REBATED AND NON-REBATED DOOR LEAVES
interior door leaves



STANDARD OPTIONS

- » stiles and rails made of MDF
- » glass pane MAT DRE 4 mm thick
- » natural veneer

OPTIONS WITHOUT ADDITIONAL CHARGE

- » glass pane DECORMAT BROWN, DECORMAT GRAPHITE and transparent glass pane
- » holes for ventilation sleeves

OPTIONS AVAILABLE WITH EXTRA CHARGE

- » steel ventilation sleeves
- » non-rebated door leaf
- » door leaf „90” and „100”
- » ventilation undercut
- » cover-up strip for double leaf non-rebated door
- » double leaf door leaf price x2
- » **NOTE:** third hinge Estetic 80 for non-rebated doors (additional payment is added to the price of the door frame)

REBATED DOOR LEAF

- » straight edge **fig. 1**
- » 3 silver screw-in pivot hinges
- » single-point mortise lock for simple key, for bathroom lock, for cylinder lock or economic lock

NON-REBATED DOOR LEAF (extra charge)

- » edge without rebate **fig. 2**
- » sockets for 2 hidden concealed Estetic 80 hinges (non-rebated door frames are equipped with hinges)
- » magnetic lock for simple key, for bathroom lock, for cylinder lock or economic lock

SLIDING SYSTEM DOOR LEAF

- » edge without rebate **fig. 2**
- » socket for hook lock and/or for handles

fig. 1

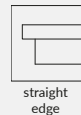

straight edge

fig. 2



edge without rebate

NOTE: There is possibility to make rebated "40" side panels.

NOTE: It is required to use together with PREMIUM rebated door leaf model door frames equipped with 3 hinges.

NOTE: The specificity of natural veneer is a possibility of differences in wood grain and staining. These differences can not be the basis of the accepted complaint.



PREMIUM natura PREMIUM 1 natura PREMIUM 2 natura PREMIUM 3 natura

natural veneer

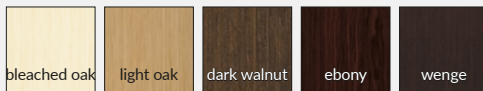

STANDARD OPTIONS

- » stiles and rails made of MDF
- » glass pane MAT DRE 4 mm thick
- » natural veneer

OPTIONS WITHOUT ADDITIONAL CHARGE

- » glass pane DECORMAT BROWN, DECORMAT GRAPHITE and transparent glass pane
- » holes for ventilation sleeves

OPTIONS AVAILABLE WITH EXTRA CHARGE

- » steel ventilation sleeves
- » non-rebated door leaf
- » door leaf „90” and „100”
- » ventilation undercut
- » cover-up strip for double leaf non-rebated door
- » double leaf door leaf price x2
- » **NOTE:** third hinge Estetic 80 for non-rebated doors (additional payment is added to the price of the door frame)

REBATED DOOR LEAF

- » straight edge **fig. 1**
- » 3 silver screw-in pivot hinges
- » single-point mortise lock for simple key, for bathroom lock, for cylinder lock or economic lock

NON-REBATED DOOR LEAF (extra charge)

- » edge without rebate **fig. 2**
- » sockets for 2 hidden concealed Estetic 80 hinges (non-rebated door frames are equipped with hinges)
- » magnetic lock for simple key, for bathroom lock, for cylinder lock or economic lock

SLIDING SYSTEM DOOR LEAF

- » edge without rebate **fig. 2**
- » socket for hook lock and/or for handles

NOTE: There is possibility to make rebated "40" side panels. It is required to use together with DOVA rebated door leaf model door frames equipped with 3 hinges.

fig. 1



fig. 2



NOTE: The specificity of natural veneer is a possibility of differences in wood grain and staining. These differences can not be the basis of the accepted complaint.

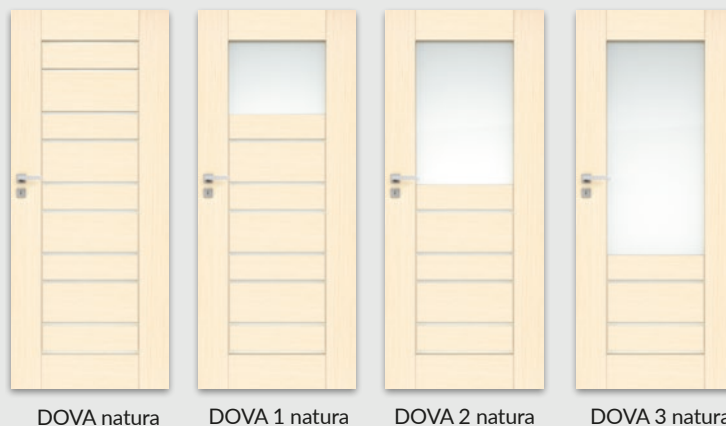

DOVA natura

DOVA 1 natura

DOVA 2 natura

DOVA 3 natura

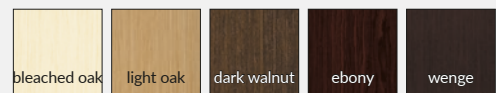

natural veneer

STANDARD OPTIONS

- » stiles and rails made of MDF
- » glass pane MAT DRE 4 mm thick
- » natural veneer
- » flat panels

OPTIONS WITHOUT ADDITIONAL CHARGE

- » glass pane DECORMAT BROWN, DECORMAT GRAPHITE and transparent glass pane
- » holes for ventilation sleeves

OPTIONS AVAILABLE WITH EXTRA CHARGE

- » steel ventilation sleeves
- » non-rebated door leaf
- » door leaf „90” and „100”
- » ventilation undercut
- » cover-up strip for double leaf non-rebated door
- » double leaf door leaf price x2
- » **NOTE:** third hinge Estetic 80 for non-rebated doors (additional payment is added to the price of the door frame)

REBATED DOOR LEAF

- » straight edge **fig. 1**
- » 3 silver screw-in pivot hinges
- » single-point mortise lock for simple key, for bathroom lock, for cylinder lock or economic lock

NON-REBATED DOOR LEAF (extra charge)

- » edge without rebate **fig. 2**
- » sockets for 2 hidden concealed Estetic 80 hinges (non-rebated door frames are equipped with hinges)
- » magnetic lock for simple key, for bathroom lock, for cylinder lock or economic lock

SLIDING SYSTEM DOOR LEAF

- » edge without rebate **fig. 2**
- » socket for hook lock and/or for handles

NOTE: There is possibility to make rebated "40" side panels.
It is required to use together with EMENA rebated door leaf model door frames equipped with 3 hinges.

fig. 1

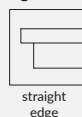
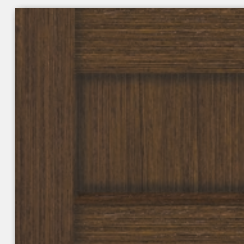
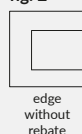

fig. 2



panel in SCALA A natura

NOTE: The specificity of natural veneer is a possibility of differences in wood grain and staining. These differences can not be the basis of the accepted complaint.

NOTE: Door handle and backplate must be purchased separately.



natural veneer

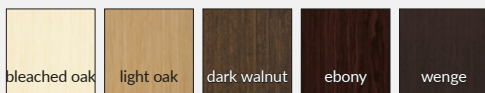

STANDARD OPTIONS

- » door leaf painted with acrylic UV varnish
- » stiles and rails made of MDF
- » glass pane MAT DRE 4 mm thick
- » profiled 19mm MDF panels

OPTIONS WITHOUT ADDITIONAL CHARGE

- » glass pane DECORMAT BROWN, DECORMAT GRAPHITE and transparent glass pane
- » holes for ventilation sleeves

OPTIONS AVAILABLE WITH EXTRA CHARGE

- » steel ventilation sleeves
- » plastic ventilation sleeves
- » non-rebated door leaf
- » door leaf „90” and „100”
- » ventilation undercut
- » cover-up strip for double leaf non-rebated door
- » double leaf door leaf price x2
- » **NOTE:** third hinge Estetic 80 for non-rebated doors (additional payment is added to the price of the door frame)

REBATED DOOR LEAF

- » straight edge **fig. 1**
- » 3 silver screw-in pivot hinges
- » single-point mortise lock for simple key, for bathroom lock, for cylinder lock or economic lock

NON-REBATED DOOR LEAF (extra charge)

- » edge without rebate **fig. 2**
- » sockets for 2 hidden concealed Estetic 80 hinges (non-rebated door frames are equipped with hinges)
- » magnetic lock for simple key, for bathroom lock, for cylinder lock or economic lock

SLIDING SYSTEM DOOR LEAF

- » edge without rebate **fig. 2**
- » socket for hook lock and/or for handles

NOTE: it is required to use together with LEXA rebated door leaf model door frames equipped with 3 hinges.

fig. 1

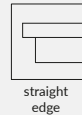

fig. 2



panel in LEXA

To ensure the highest quality of painted products, before painting process, both, door leaves and door frames are coated with special material which constitutes solid base.



Decor

white acrylic UV varnish - RAL 9003
ecru - RAL 9001
latte - Flügger 4362, NCS S1505-Y50R
ashen - RAL 7035



BERGE 6 - white

Decor



white acrylic UV varnish - RAL 9003
ecru - RAL 9001
latte - Flugger 4362, NCS S1505-Y50R
ashen - RAL 7035

STANDARD OPTIONS

- » door leaf painted with acrylic UV varnish
- » stiles and rails made of MDF
- » glass pane MAT DRE 4 mm thick
- » profiled 19mm MDF panels

OPTIONS WITHOUT ADDITIONAL CHARGE

- » glass pane DECORMAT BROWN, DECORMAT GRAPHITE and transparent glass pane
- » holes for ventilation sleeves

OPTIONS AVAILABLE WITH EXTRA CHARGE

- » steel ventilation sleeves
- » plastic ventilation sleeves
- » non-rebated door leaf
- » door leaf „90” and „100”
- » ventilation undercut
- » cover-up strip for double leaf non-rebated door
- » double leaf door leaf price x2
- » **NOTE:** third hinge Estetic 80 for non-rebated doors (additional payment is added to the price of the door frame)

REBATED DOOR LEAF

- » straight edge **fig. 1**
- » 3 silver screw-in pivot hinges
- » single-point mortise lock for simple key, for bathroom lock, for cylinder lock or economic lock

NON-REBATED DOOR LEAF (extra charge)

- » edge without rebate **fig. 2**
- » sockets for 2 hidden concealed Estetic 80 hinges (non-rebated door frames are equipped with hinges)
- » magnetic lock for simple key, for bathroom lock, for cylinder lock or economic lock

SLIDING SYSTEM DOOR LEAF

- » edge without rebate **fig. 2**
- » socket for hook lock and/or for handles

NOTE: It is required to use together with BERGE rebated door leaf model door frames equipped with 3 hinges.

fig. 1

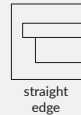

fig. 2



To ensure the highest quality of painted products, before painting process, both, door leaf and door frames are coated with special material which constitutes solid base.





EVEN - gray

Decor



white acrylic UV varnish - RAL 9003
 ecru - RAL 9001
 latte - Flugger 4362, NCS S1505-Y50R
 ashen - RAL 7035

STANDARD OPTIONS

- » door leaf painted with acrylic UV varnish
- » stiles and rails made of MDF
- » glass pane MAT DRE 4 mm thick

OPTIONS WITHOUT ADDITIONAL CHARGE

- » glass pane DECORMAT BROWN, DECORMAT GRAPHITE and transparent glass pane
- » holes for ventilation sleeves

REBATED DOOR LEAF

- » straight edge **fig. 1**
- » 3 silver screw-in pivot hinges
- » single-point mortise lock for simple key, for bathroom lock, for cylinder lock or economic lock

NON-REBATED DOOR LEAF (extra charge)

- » edge without rebate **fig. 2**
- » sockets for 2 hidden concealed Estetic 80 hinges (non-rebated door frames are equipped with hinges)
- » magnetic lock for simple key, for bathroom lock, for cylinder lock or economic lock

SLIDING SYSTEM DOOR LEAF

- » edge without rebate **fig. 2**
- » socket for hook lock and/or for handles

NOTE: It is required to use together with rebated door leaf door frames equipped with 3 hinges.

OPTIONS AVAILABLE WITH EXTRA CHARGE

- » steel ventilation sleeves
- » plastic ventilation sleeves
- » non-rebated door leaf
- » door leaf „90” and „100”
- » ventilation undercut
- » cover-up strip for double leaf non-rebated door
- » double leaf door leaf price x2
- » **NOTE:** third hinge Estetic 80 for non-rebated doors (additional payment is added to the price of the door frame)

fig. 1



fig. 2



To ensure the highest quality of painted products, before painting process, both, door leaves and door frames are coated with special material which constitutes solid base.





NESTOR 3 - ashen

Decor



white acrylic UV varnish - RAL 9003
 ecru - RAL 9001
 latte - Flugger 4362, NCS S1505-Y50R
 ashen - RAL 7035

STANDARD OPTIONS

- » door leaf painted with acrylic UV varnish
- » stiles and rails made of MDF
- » glass pane MAT DRE 4 mm thick
- » profiled 19mm MDF panels

OPTIONS WITHOUT ADDITIONAL CHARGE

- » glass pane DECORMAT BROWN, DECORMAT GRAPHITE and transparent glass pane
- » holes for ventilation sleeves

REBATED DOOR LEAF

- » straight edge **fig. 1**
- » 3 silver screw-in pivot hinges
- » single-point mortise lock for simple key, for bathroom lock, for cylinder lock or economic lock

NON-REBATED DOOR LEAF (extra charge)

- » edge without rebate **fig. 2**
- » sockets for 2 hidden concealed Estetic 80 hinges (non-rebated door frames are equipped with hinges)
- » magnetic lock for simple key, for bathroom lock, for cylinder lock or economic lock

SLIDING SYSTEM DOOR LEAF

- » edge without rebate **fig. 2**
- » socket for hook lock and/or for handles

NOTE: It is required to use together with NESTOR rebated door leaf model door frames equipped with 3 hinges.

OPTIONS AVAILABLE WITH EXTRA CHARGE

- » steel ventilation sleeves
- » plastic ventilation sleeves
- » non-rebated door leaf
- » door leaf „90" and „100"
- » ventilation undercut
- » cover-up strip for double leaf non-rebated door
- » double leaf door leaf price x2
- » **NOTE:** third hinge Estetic 80 for non-rebated doors (additional payment is added to the price of the door frame)

fig. 1



fig. 2



panel in NESTOR

To ensure the highest quality of painted products, before painting process, both, door leaves and door frames are coated with special material which constitutes solid base.





VETRO E - white

Decor



white acrylic UV varnish - RAL 9003
 ecru - RAL 9001
 latte - Flugger 4362, NCS S1505-Y50R
 ashen - RAL 7035

Horizontal cross-section of VETRO E door leaf

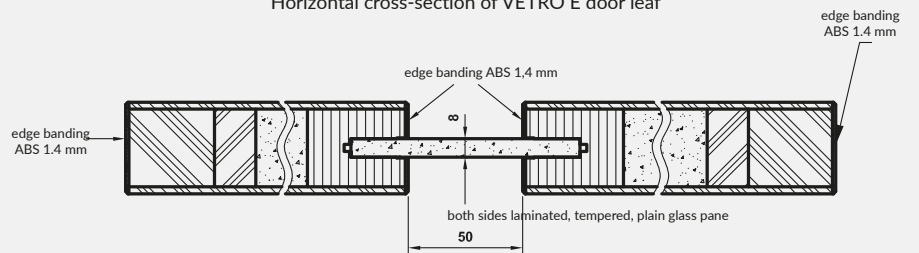

STANDARD OPTIONS

- » door leaf painted with acrylic UV varnish
- » frame made of MDF additionally reinforced with plywood:
narrow element with fixed width, wide element with different width
- » core made of perforated chipboard
- » DECORMAT tempered laminated 8 mm glass pane with fixed width (regardless the width of the door leaf) or laminated black tempered 8 mm glass pane (opaque) with fixed width (regardless width of the door leaf)

NON-REBATED DOOR LEAF

- » edge without rebate **fig.1**
- » sockets for 2 hidden concealed Estetic 80 hinges (non-rebated door frames are equipped with hinges)
- » magnetic lock for simple key, for bathroom lock, for cylinder lock or economic lock

NOTE: There is no possibility to shorten door leaf.

There is no possibility to make ventilation undercut.
VETRO E - does not fulfill ventilation requirements.

To ensure the highest quality of painted products, before painting process, both, door leaves and door frames are coated with special material which constitutes solid base.

OPTIONS AVAILABLE WITH EXTRA CHARGE

- » **NOTE:** third hinge Estetic 80 for non-rebated doors (additional payment is added to the price of the door frame)

fig. 1

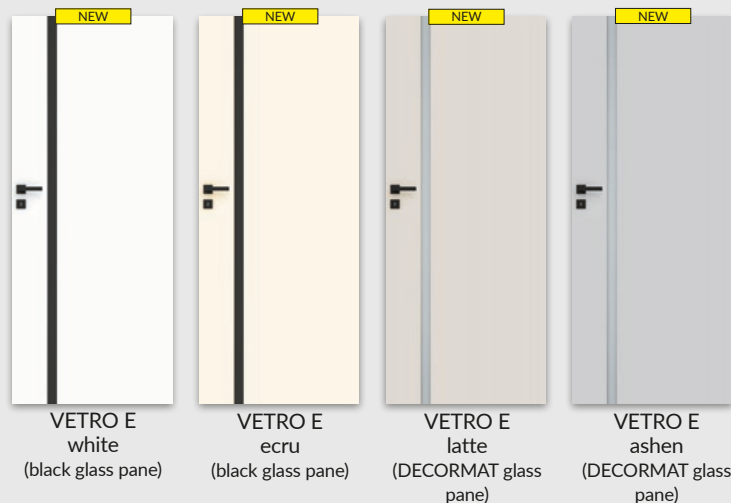



TIXA - welsh oak

CPL
laminate

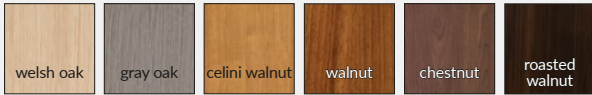

STANDARD OPTIONS

- » rails made of softwood and MDF board
- » glass pane MAT DRE 4 mm thick

OPTIONS WITHOUT ADDITIONAL CHARGE

- » glass pane DECORMAT BROWN, DECORMAT GRAPHITE and transparent glass pane
- » holes for ventilation sleeves

OPTIONS AVAILABLE WITH EXTRA CHARGE

- » steel ventilation sleeves
- » non-rebated door leaf
- » door leaf „90” and „100”
- » ventilation undercut
- » cover-up strip for double leaf non-rebated door
- » double leaf door leaf price x2
- » **NOTE:** third hinge Estetic 80 for non-rebated doors (additional payment is added to the price of the door frame)

REBATED DOOR LEAF

- » straight edge **fig. 1**
- » 3 silver screw-in pivot hinges
- » single-point mortise lock for simple key, for bathroom lock, for cylinder lock or economic lock

NON-REBATED DOOR LEAF (extra charge)

- » edge without rebate **fig. 2**
- » sockets for 2 hidden concealed Estetic 80 hinges (non-rebated door frames are equipped with hinges)
- » magnetic lock for simple key, for bathroom lock, for cylinder lock or economic lock

NOTE: it is required to use together with TIXA door leaf model door frames equipped with 3 hinges.

fig. 1



fig. 2



CROSS-SECTION OF VERTICAL STILE

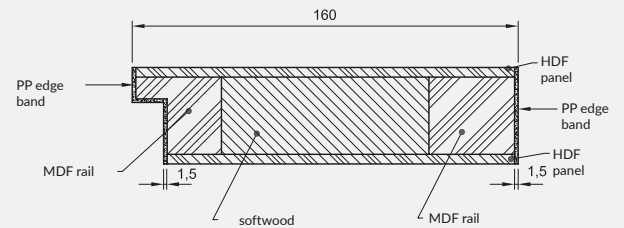



TIZANO 1 - welsh oak

CPL
laminate

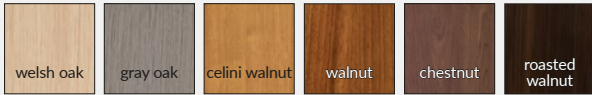

STANDARD OPTIONS

- » rails made of softwood and MDF board
- » glass pane MAT DRE 4 mm thick

OPTIONS WITHOUT ADDITIONAL CHARGE

- » glass pane DECORMAT BROWN, DECORMAT GRAPHITE and transparent glass pane
- » holes for ventilation sleeves

OPTIONS AVAILABLE WITH EXTRA CHARGE

- » steel ventilation sleeves
- » non-rebated door leaf
- » door leaf „90” and „100”
- » ventilation undercut
- » cover-up strip for double leaf non-rebated door
- » double leaf door leaf price x2
- » **NOTE:** third hinge Estetic 80 for non-rebated doors (additional payment is added to the price of the door frame)

REBATED DOOR LEAF

- » straight edge **fig. 1**
- » 3 silver screw-in pivot hinges
- » single-point mortise lock for simple key, for bathroom lock, for cylinder lock or economic lock

NON-REBATED DOOR LEAF (extra charge)

- » edge without rebate **fig. 2**
- » sockets for 2 hidden concealed Estetic 80 hinges (non-rebated door frames are equipped with hinges)
- » magnetic lock for simple key, for bathroom lock, for cylinder lock or economic lock

NOTE: It is required to use together with TIZANO rebated door leaf model door frames equipped with 3 hinges.

fig. 1



straight edge

fig. 2



edge without rebate

CROSS-SECTION OF VERTICAL STILE

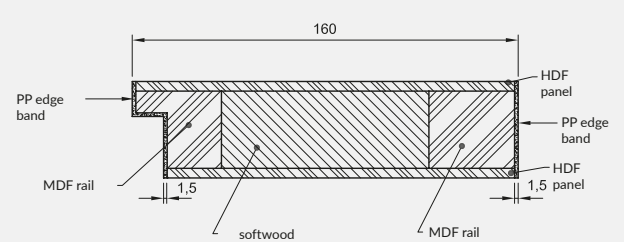

TIZANO 1

TIZANO 2

TIZANO 3

TIZANO 4

TIZANO 5

TIZANO 6



RIVIA 10 - white mat / vintage oak

Decor DRE-Cell	white mat	white pine	siberian elm	silver	sand oak	bleached oak textured	ash	vintage oak	beech	alder	golden oak	golden oak textured	calvados
	walnut	caramel walnut	dark walnut textured	gray oak textured	tabac elm	anthracite elm	dark wenge	gray textured	black textured	toffee oak			
Decor 3D	grand oak	elm	american walnut	ebony	polish oak 3D								

STANDARD OPTIONS

- » door leaf frame made of softwood
- » core made of perforated chipboard
- » glass pane white bark 4 mm thick

OPTIONS WITHOUT ADDITIONAL CHARGE

- » glass pane „chinchila” or „window blind”
- » ventilation sleeves
- » three hinges - applies to rebated door leaf

REBATED DOOR LEAF

- » straight edge, flat uniform glazing bar **fig. 1**
- » 2 silver screw-in pivot hinges
- » single-point mortise lock for simple key, for bathroom lock, for cylinder lock or economic lock

NON-REBATED DOOR LEAF (extra charge)

- » edge without rebate, flat uniform glazing bar, **rys. 2**
- » sockets for 2 hidden concealed Estetic 80 hinges (non-rebated door frames are equipped with hinges)
- » magnetic lock for simple key, for bathroom lock, for cylinder lock or economic lock

SLIDING SYSTEM DOOR LEAF

- » edge without rebate, flat uniform glazing bar **fig. 2**
- » socket for hook lock and/or for handles

NOTE: Door leaf is coated with decor white mat. There is possibility to choose middle stripe in the selected decor. Edgeband is in the colour of selected decor. RIVIA 50 - BULAJ is coated with silver laminate.

*** In RIVIA 70 and 120 model, colour of the selected decor has vertical wood grain, except of decor gray oak texture. In remaining models decors have horizontal wood grain.

OPTIONS AVAILABLE WITH EXTRA CHARGE

- » glass pane MAT DRE, DECORMAT BROWN, DECORMAT GRAPHITE, (applies to door leaf)
RIVIA 20, 30
RIVIA 40, 50
- » white frost VSG 22.1 safe, complex glass pane
RIVIA 20, 30
RIVIA 40, 50
non-rebated door leaves
- » door leaf „90” and „100”
- » ventilation undercut
- » plastic ventilation grille
- » aluminum ventilation grille
- » **NOTE:** third hinge Estetic 80 for non-rebated doors (additional payment is added to the price of the door frame)

NEW

fig. 1

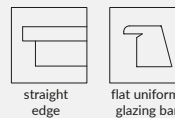
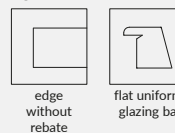

fig. 2





ALU 20 GALLERY - black textured

Decor DRE-Cell 1	white (structure)	ash	beech	alder	golden oak	calvados	walnut						
Decor DRE-Cell 2	white mat	white pine	siberian elm	silver	sand oak	bleached oak textured	vintage oak	caramel walnut	golden oak textured	dark walnut textured	gray oak textured***		
	tabac elm	anthracite elm	dark wenge	gray textured	black textured	toffee oak***							
Decor 3D	grand oak	elm	american walnut	ebony	polish oak 3D								
CPL laminate**	white	noble white VVF7206	light gray	dark gray	concrete 1 F6462	concrete 2	gray oak						
	welsh oak	acacia	celini walnut	walnut	honey oak	chestnut	roasted walnut						

** laminate available in models 10, 20, 30, 50, 60
 *** decor available only in horizontal wood grain

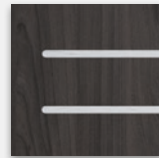

aluminum marquetry elements with cross-section 8x2 mm installed on both sides in one surface of door leaf

STANDARD OPTIONS

- » door leaf frame made of softwood
- » core made of perforated chipboard
- » edge with radius R 2,5 mm used in 0,15-0,20 mm CPL laminates
- » aluminum marquetry elements with cross-section 8x2mm
- » glass pane white bark 4 mm thick

OPTIONS WITHOUT ADDITIONAL CHARGE

- » glass pane „chinchila” or „window blind”
- » ventilation sleeves
- » three hinges - applies to rebated door leaf

REBATED DOOR LEAF

- » straight edge, flat glazing bar **fig. 1**
- » 2 silver screw-in pivot hinges
- » single-point mortise lock for simple key, for bathroom lock, for cylinder lock or economic lock
- » straight edge coated with edge banding 1,5 mm or edge with profile R 2,5 mm made in method of directforming (in CPL laminate) **fig. 3**

NON-REBATED DOOR LEAF (EXTRA CHARGE)

- » edge without rebate, flat glazing bar **fig. 2**
- » sockets for 2 hidden concealed Estetic 80 hinges (non-rebated door frames are equipped with hinges)
- » magnetic lock for simple key, for bathroom lock, for cylinder lock or economic lock
- » edge without rebate (in CPL laminate) **fig 4**

SLIDING SYSTEM DOOR LEAF

- » edge without rebate, flat glazing bar **fig. 2**
- » socket for hook lock and/or for handles

NOTE: Passive door leaf GALERIA ALU 20,21,22,23,24,25,60 are not equipped with aluminum marquetry elements in uniform wood grain..

OPTIONS AVAILABLE WITH EXTRA CHARGE

- » straight edge and edge without rebate finished with 1,5 mm edgeband in CPL laminates
- » glass pane MAT DRE, DECORMAT BROWN, DECORMAT GRAPHITE, (applies to door leaf)
GALERIA ALU 11, 13, 23
GALERIA ALU 21
GALERIA ALU 24, 25
GALERIA ALU 12, 22
- » white frost VSG 22.1 safe, complex glass pane
GALERIA ALU 11
GALERIA ALU 13, 23
GALERIA ALU 21
GALERIA ALU 24
GALERIA ALU 25
GALERIA ALU 12
GALERIA ALU 22
- » non-rebated door leaf
» door leaf „90” and „100”
- » ventilation undercut
» plastic ventilation grille
» aluminum ventilation grille
- » cover-up strip for double leaf non-rebated door
» double leaf door leaf price x2
- » **NOTE:** third hinge Estetic 80 for non-rebated doors (additional payment is added to the price of the door frame)

NEW

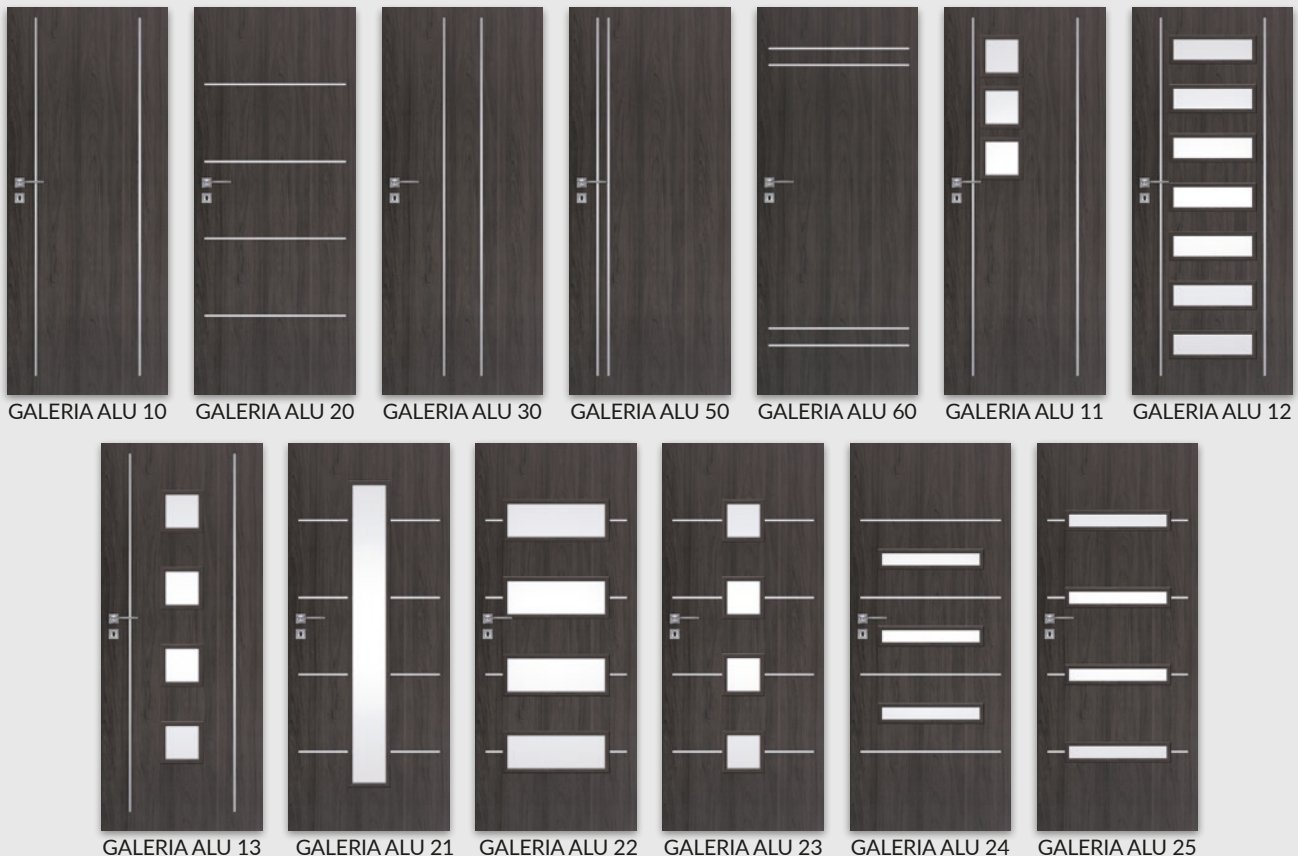
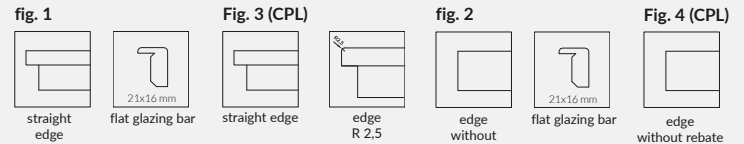



ALDEA 40 - gray structure

Decor DRE-Cell 1	white (structure)	ash	beech	alder	golden oak	calvados	walnut					
Decor DRE-Cell 2	white mat	white pine	siberian elm	silver	sand oak	bleached oak textured	vintage oak	caramel walnut	golden oak textured	dark walnut textured	gray oak textured***	
	tabac elm	anthracite elm	dark wenge	gray textured	black textured	toffee oak***						
Decor 3D	grand oak	elm	american walnut	ebony	polish oak 3D							

*** Decor available only in horizontal wood grain

STANDARD OPTIONS

- » door leaf frame made of softwood
- » core made of „honeycomb“
- » glass pane white bark 4 mm thick

OPTIONS WITHOUT ADDITIONAL CHARGE

- » glass pane „chinchila“ or „window blind“
- » ventilation sleeves
- » three hinges - applies to rebated door leaf

REBATED DOOR LEAF

- » straight edge, flat glazing bar, 19 mm MDF profiled panels **fig. 1**
- » 2 silver screw-in pivot hinges
- » single-point mortise lock for simple key, for bathroom lock, for cylinder lock or economic lock

NON-REBATED DOOR LEAF (extra charge)

- » edge without rebate, flat glazing bar, 19 mm MDF profiled panels **fig. 2**
- » sockets for 2 hidden concealed Estetic 80 hinges (non-rebated door frames are equipped with hinges)
- » magnetic lock for simple key, for bathroom lock, for cylinder lock or economic lock

SLIDING SYSTEM DOOR LEAF

- » edge without rebate, flat glazing bar, 19 mm MDF profiled panels **fig. 2**
- » socket for hook lock and/or for handles

OPTIONS AVAILABLE WITH EXTRA CHARGE

- » glass pane MAT DRE, DECORMAT BROWN, DECORMAT GRAPHITE, (applies to door leaf)

ALDEA 20
ALDEA 30
ALDEA 40
ALDEA 50
ALDEA 60

- » white frost VSG 22.1 safe, complex glass pane

ALDEA 20
ALDEA 30
ALDEA 40
ALDEA 50
ALDEA 60

- » core made of perforated chipboard

- » non-rebated door leaf
- » door leaf „90“ and „100“
- » ventilation undercut

- » plastic ventilation grille
- » aluminum ventilation grille

- » cover-up strip for double leaf non-rebated door
- » double leaf door

leaf price x2

- » **NOTE:** third hinge Estetic 80 for non-rebated doors (additional payment is added to the price of the door frame)

NEW

fig. 1

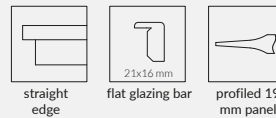
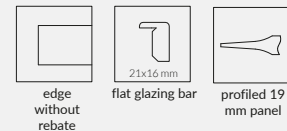

fig. 2





ARTE B 60 - caramel walnut

Decor DRE-Cell 1	white (structure)	ash	beech	alder	golden oak	calvados	walnut						
Decor DRE-Cell 2	white mat	white pine	siberian elm	silver	sand oak	bleached oak textured	vintage oak	caramel walnut	golden oak textured	dark walnut textured	gray oak textured***		
	tabac elm	anthracite elm	dark wenge	gray textured	black textured	toffee oak***							
Decor 3D	grand oak	elm	american walnut	ebony	polish oak 3D								

*** Decor available only in horizontal wood grain

STANDARD OPTIONS

- » door leaf frame made of softwood
- » core made of „honeycomb“
- » glass pane white bark 4 mm thick

OPTIONS WITHOUT ADDITIONAL CHARGE

- » glass pane „chinchila“ or „window blind“
- » ventilation sleeves
- » three hinges - applies to rebated door leaf

REBATED DOOR LEAF

- » straight edge, flat glazing bar **fig. 1**
- » 2 silver screw-in pivot hinges
- » single-point mortise lock for simple key, for bathroom lock, for cylinder lock or economic lock

NON-REBATED DOOR LEAF (extra charge)

- » edge without rebate, flat glazing bar, **fig. 2**
- » sockets for 2 hidden concealed Estetic 80 hinges (non-rebated door frames are equipped with hinges)
- » magnetic lock for simple key, for bathroom lock, for cylinder lock or economic lock

SLIDING SYSTEM DOOR LEAF

- » edge without rebate, flat glazing bar **fig. 2**
- » socket for hook lock and/or for handles

OPTIONS AVAILABLE WITH EXTRA CHARGE

- » glass pane MAT DRE, DECORMAT BROWN, DECORMAT GRAPHITE (applies to the door leaf) ARTE B 10, 20, 30 ARTE B 40, 50 ARTE B 60
- » white frost VSG 22.1 safe, complex glass pane ARTE B 10, 20, 30 ARTE B 40, 50 ARTE B 60
- » core made of perforated chipboard
- » non-rebated door leaf
- » door leaf „90“ and „100“
- » ventilation undercut
- » plastic ventilation grille
- » aluminum ventilation grille
- » cover-up strip for double leaf non-rebated door
- » double leaf door leaf price x2
- » **NOTE:** third hinge Estetic 80 for non-rebated doors (additional payment is added to the price of the door frame)

NEW

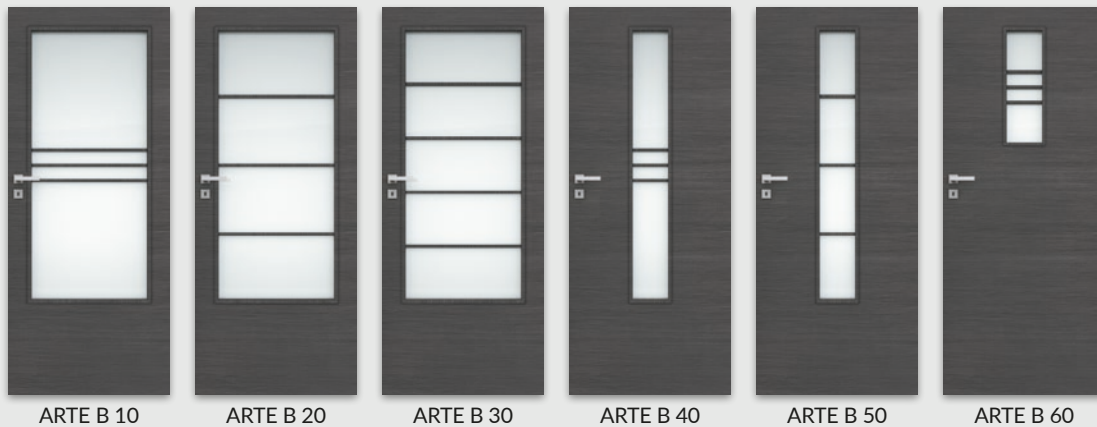
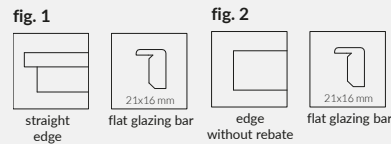



CARLA 10 grand oak

Decor DRE-Cell 1	white (structure)	ash	beech	alder	golden oak	calvados	walnut						
Decor DRE-Cell 2	white mat	white pine	siberian elm	silver	sand oak	bleached oak textured	vintage oak	caramel walnut	golden oak textured	dark walnut textured	gray oak textured***		
	tabac elm	anthracite elm	dark wenge	gray textured	black textured	toffee oak***							
Decor 3D	grand oak	elm	american walnut	ebony	polish oak 3D								

*** decor available only in horizontal wood grain

STANDARD OPTIONS

- » door leaf frame made of softwood
- » core made of „honeycomb“
- » glass pane white bark 4 mm thick

OPTIONS WITHOUT ADDITIONAL CHARGE

- » glass pane „chinchila“ or „window blind“
- » ventilation sleeves
- » three hinges - applies to rebated door leaf

REBATED DOOR LEAF

- » straight edge, flat glazing bar, 19 mm MDF profiled panels **fig. 1**
- » 2 silver screw-in pivot hinges
- » single-point mortise lock for simple key, for bathroom lock, for cylinder lock or economic lock

NON-REBATED DOOR LEAF (extra charge)

- » edge without rebate, flat glazing bar, 19 mm MDF profiled panels **fig. 2**
- » sockets for 2 hidden concealed Estetic 80 hinges (non-rebated door frames are equipped with hinges)
- » magnetic lock for simple key, for bathroom lock, for cylinder lock or economic lock

SLIDING SYSTEM DOOR LEAF

- » edge without rebate, flat glazing bar, 19 mm MDF profiled panels **fig. 2**
- » socket for hook lock and/or for handles

OPTIONS AVAILABLE WITH EXTRA CHARGE

- » glass pane MAT DRE, DECORMAT BROWN, DECORMAT GRAPHITE (applies to door leaf)
CARLA 20
CARLA 30
CARLA 40
- » white frost VSG 22.1 safe, complex glass pane **NEW**
CARLA 20
CARLA 30
CARLA 40
- » core made of perforated chipboard
- » non-rebated door leaf
- » door leaf „90“ and „100“
- » ventilation undercut
- » plastic ventilation grille
- » aluminum ventilation grille
- » cover-up strip for double leaf non-rebated door
- » double leaf door leaf price x2
- » **NOTE:** third hinge Estetic 80 for non-rebated doors (additional payment is added to the price of the door frame)

fig. 1



fig. 2

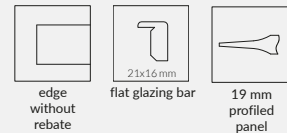



BLANCO 110 with mirror - white mat

Decor
DRE-Cell



STANDARD OPTIONS

- » door leaf frame made of softwood
- » core made of „honeycomb“
- » glass pane white bark 4 mm thick
- » 8 mm complex mirror in BLANCO 110

OPTIONS WITHOUT ADDITIONAL CHARGE

- » glass pane „chinchila“ or „window blind“
- » ventilation sleeves
- » three hinges - applies to rebated door leaf

REBATED DOOR LEAF

- » straight edge, flat uniform glazing bar **fig. 1**
- » 2 silver screw-in pivot hinges
- » single-point mortise lock for simple key, for bathroom lock, for cylinder lock or economic lock

NON-REBATED DOOR LEAF (extra charge)

- » edge without rebate, flat uniform glazing bar **fig. 2**
- » sockets for 2 hidden concealed Estetic 80 hinges (non-rebated door frames are equipped with hinges)
- » magnetic lock for simple key, for bathroom lock, for cylinder lock or economic lock

SLIDING SYSTEM DOOR LEAF

- » edge without rebate, flat uniform glazing bar **fig. 2**
- » socket for hook lock and/or for handles

OPTIONS AVAILABLE WITH EXTRA CHARGE

- » glass pane MAT DRE, DECORMAT BROWN, DECORMAT GRAPHITE (applies to door leaf)
BLANCO 10, 80
BLANCO 20-40
BLANCO 50
BLANCO 60, 100
BLANCO 70
BLANCO 90
- » non-rebated door leaf
- » core made of perforated chipboard
- » door leaf „90“ and „100“
- » ventilation undercut
- » plastic ventilation grille
- » aluminum ventilation grille
- » cover-up strip for double leaf non-rebated door
- » double leaf door leaf price x2
- » **NOTE:** third hinge Estetic 80 for non-rebated doors (additional payment is added to the price of the door frame)

fig. 1

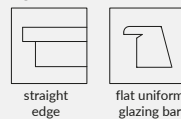
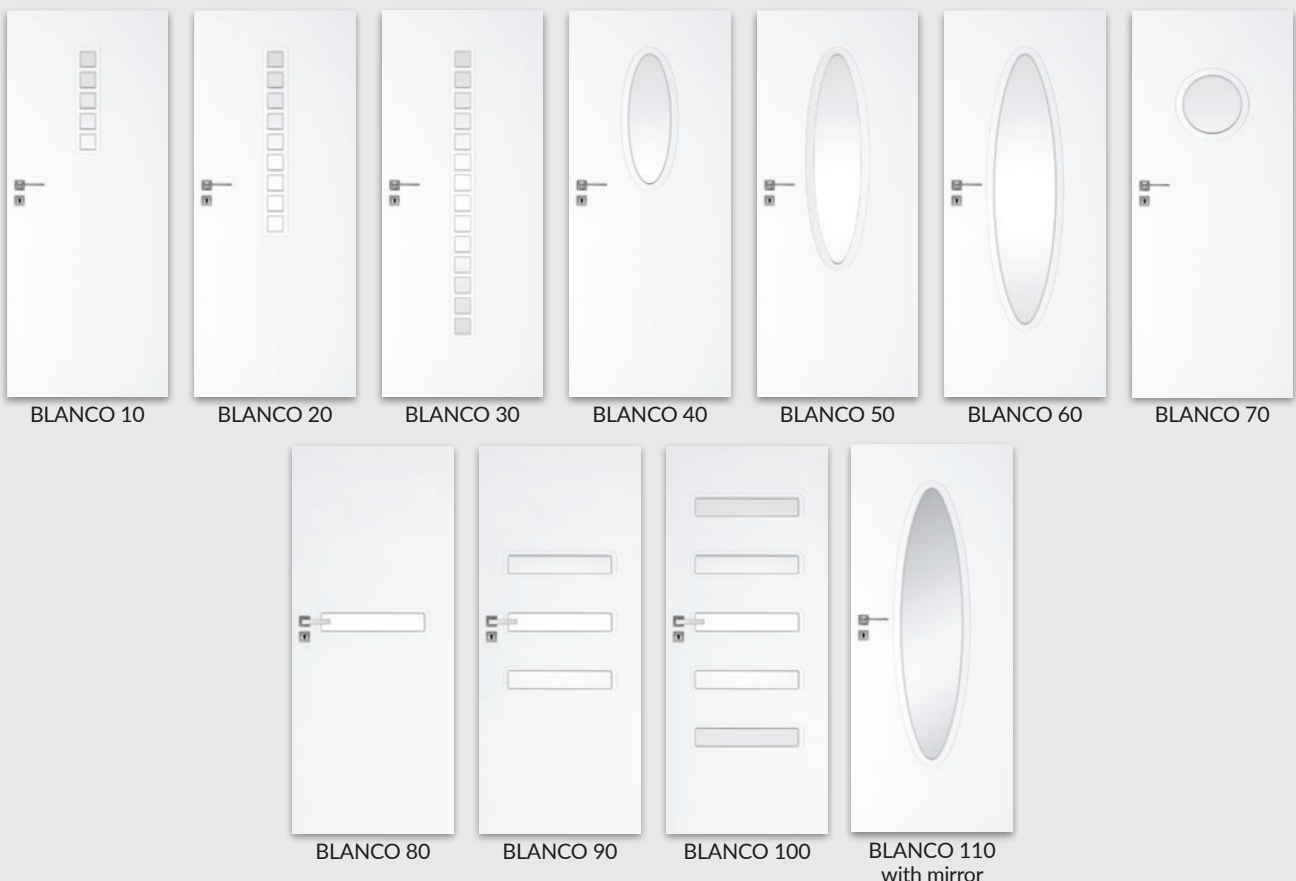
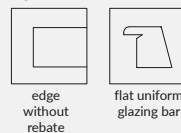

fig. 2





FINEA 40 vintage oak

Decor DRE-Cell 1	white (structure)	ash	beech	alder	golden oak	calvados	walnut						
Decor DRE-Cell 2	white mat	white pine	siberian elm	silver	sand oak	bleached oak textured	vintage oak	caramel walnut	golden oak textured	dark walnut textured	gray oak textured		
	tabac elm	anthracite elm	dark wenge	gray textured	black textured	toffee oak							
Decor 3D	grand oak	elm	american walnut	ebony	polish oak 3D								

STANDARD OPTIONS

- » door leaf frame made of softwood
- » core made of perforated chipboard
- » glass pane white bark 4 mm thick

OPTIONS WITHOUT ADDITIONAL CHARGE

- » glass pane „chinchila” or „window blind”
- » ventilation sleeves
- » three hinges - applies to rebated door leaf

REBATED DOOR LEAF

- » straight edge, flat glazing bar **fig. 1**
- » 2 silver screw-in pivot hinges
- » single-point mortise lock for simple key, for bathroom lock, for cylinder lock or economic lock

NON-REBATED DOOR LEAF (EXTRA CHARGE)

- » edge without rebate, flat glazing bar **fig. 2**
- » sockets for 2 hidden concealed Estetic 80 hinges (non-rebated door frames are equipped with hinges)
- » magnetic lock for simple key, for bathroom lock, for cylinder lock or economic lock

SLIDING SYSTEM DOOR LEAF

- » edge without rebate, flat glazing bar **fig. 2**
- » socket for hook lock and/or for handles

OPTIONS AVAILABLE WITH EXTRA CHARGE

- » glass pane MAT DRE, DECORMAT BROWN, DECORMAT GRAPHITE (applies to door leaf) FINEA 20, FINEA B 20 FINEA 30, 50, 60, FINEA B 30, 50, 60
- » white frost VSG 22.1 safe, complex glass pane FINEA 20, FINEA B 20 FINEA 30, FINEA B 30 FINEA 50, 60, FINEA B 50, 60
- » non-rebated door leaf
- » door leaf „90” and „100”
- » ventilation undercut
- » plastic ventilation grille
- » aluminum ventilation grille
- » **NOTE:** third hinge Estetic 80 for non-rebated doors (additional payment is added to the price of the door frame)

NEW

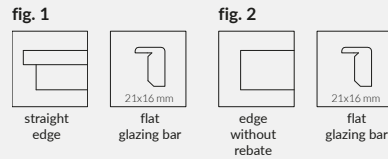

* FINEA B panels available only with horizontal wood grain

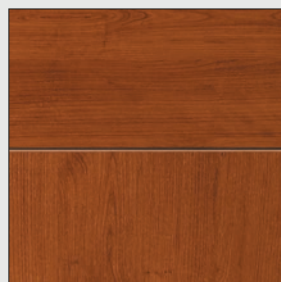

wood grain in FINEA panels

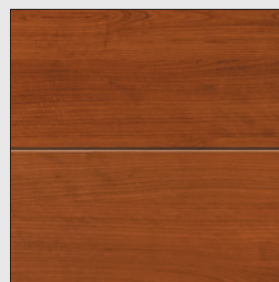

horizontal wood grain in FINEA B panels



DECO 20 - toffee oak

Decor DRE-Cell 1	white (structure)	ash	beech	alder	golden oak	calvados	walnut						
Decor DRE-Cell 2	white mat*	white pine	siberian elm	silver	sand oak	bleached oak textured	vintage oak	caramel walnut	golden oak textured	dark walnut textured	gray oak textured***		
	tabac elm	anthracite elm	dark wenge	gray textured	black textured	toffee oak***							
Decor 3D	grand oak	elm	american walnut	ebony	polish oak 3D								
Laminate CPL	white	noble white VVF7206	light gray	dark gray	concrete 1 F6462	concrete 2	gray oak						
	welsh oak	acacia	celini walnut	walnut	honey oak	chestnut	roasted walnut						

*** decor available only in horizontal wood grain

* decor is not available in door leaf model with "karnies" edge

*** decor available only in horizontal wood grain

STANDARD OPTIONS

- » door leaf frame made of softwood
- » edge with radius R 2,5 mm used in 0,15-0,20 mm CPL laminates
- » core made of „honeycomb“
- » glass pane white bark 4 mm thick
- » flat 4mm HDF panel in DECO 40

OPTIONS WITHOUT ADDITIONAL CHARGE

- » glass pane „chinchila“ or „window blind“
- » ventilation sleeves
- » three hinges - applies to rebated door leaf

REBATED DOOR LEAF

- » optional: straight edge, flat glazing bar fig. 1 or "karnies" edge, rounded glazing bar fig. 2
- » 2 silver screw-in pivot hinges
- » single-point mortise lock for simple key, for bathroom lock, for cylinder lock or economic lock
- » rounded glazing bar, straight edge coated with 1,5 mm edgeband or edge with radius R 2,5 mm finished with method of directforming (in CPL laminate) fig. 5

NON-REBATED DOOR LEAF (extra charge)

- » edge without rebate, flat glazing bar fig. 3
- » sockets for 2 hidden concealed Estetic 80 hinges (non-rebated door frames are equipped with hinges)
- » magnetic lock for simple key, for bathroom lock, for cylinder lock or economic lock
- » edge without rebate, rounded glazing bar (in CPL laminate) fig. 6

SLIDING SYSTEM DOOR LEAF

- » edge without rebate and optional: flat glazing bar fig.3 or rounded glazing bar fig. 4
- » socket for hook lock and/or for handles
- » edge without rebate, rounded glazing bar (in CPL laminate) fig. 6

OPTIONS AVAILABLE WITH EXTRA CHARGE

- » straight edge and edge without rebate finished with 1,5 mm edgeband in CPL laminates
- » glass pane MAT DRE, DECORMAT BROWN, DECORMAT GRAPHITE (applies to door leaf) DECO 10, 20, 30
- » white frost VSG 22.1 safe, complex glass pane DECO 10, 20, 30
- » core made of perforated chipboard
- » non-rebated door leaf
- » door leaf „90“ and „100“
- » ventilation undercut
- » plastic ventilation grille
- » aluminum ventilation grille
- » cover-up strip for double leaf non-rebated door
- » double leaf door leaf price x2
- » **NOTE:** third hinge Estetic 80 for non-rebated doors (additional payment is added to the price of the door frame)

NEW

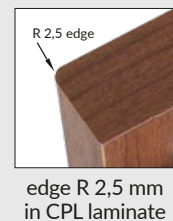
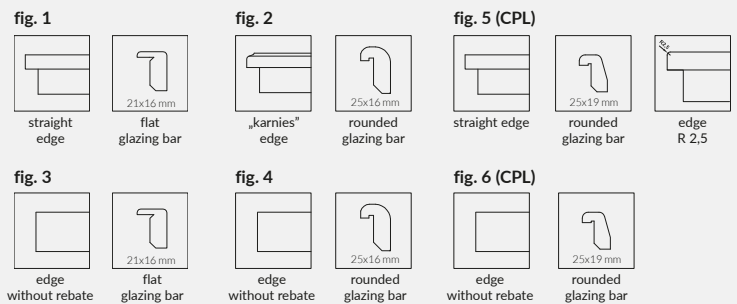



MODERN 10 - white pine

Decor DRE-Cell 1	white (structure)	ash	beech	alder	golden oak	calvados	walnut							
Decor DRE-Cell 2	white mat*	white pine	siberian elm	silver	sand oak	bleached oak textured	vintage oak	caramel walnut	golden oak textured	dark walnut textured	gray oak textured***			
	tabac elm	anthracite elm	dark wenge	gray textured	black textured	toffee oak***								
Decor 3D	grand oak	elm	american walnut	ebony	polish oak 3D									

* Decor is not available in door leaf model with "karnies" edge
 *** Decor available only in horizontal wood grain

STANDARD OPTIONS

- » door leaf frame made of softwood
- » core made of „honeycomb”
- » glass pane white bark 4 mm thick

OPTIONS WITHOUT ADDITIONAL CHARGE

- » glass pane „chinchila” or „window blind”
- » ventilation sleeves
- » three hinges - applies to rebated door leaf

REBATED DOOR LEAF

- » optional: straight edge, flat glazing bar, flat 4 mm HDF panels **fig. 1** or „karnies” edge, rounded glazing bar, profiled 19 mm MDF panels **fig. 2**
- » 2 silver screw-in pivot hinges
- » single-point mortise lock for simple key, for bathroom lock, for cylinder lock or economic lock

NON-REBATED DOOR LEAF (extra charge)

- » edge without rebate, flat glazing bar, flat 4 mm HDF panels **fig. 3**
- » sockets for 2 hidden concealed Estetic 80 hinges (non-rebated door frames are equipped with hinges)
- » magnetic lock for simple key, for bathroom lock, for cylinder lock or economic lock

SLIDING SYSTEM DOOR LEAF

- » edge without rebate and optional: flat glazing bar, flat 4 mm HDF panels **fig. 3** or rounded glazing bar, profiled 19 mm MDF panels **fig. 4**
- » socket for hook lock and/or for handles

OPTIONS AVAILABLE WITH EXTRA CHARGE

- » glass pane MAT DRE, DECORMAT BROWN, DECORMAT GRAPHITE, (applies to door leaf) MODERN 20 MODERN 30 MODERN 40 MODERN 50
- » white frost VSG 22.1 safe, complex glass pane MODERN 20 MODERN 30 MODERN 40 MODERN 50
- » core made of perforated chipboard
- » non-rebated door leaf
- » door leaf „90” and „100”
- » ventilation undercut
- » plastic ventilation grille
- » aluminum ventilation grille
- » cover-up strip for double leaf non-rebated door
- » double leaf door leaf price x2
- » **NOTE:** third hinge Estetic 80 for non-rebated doors (additional payment is added to the price of the door frame)

NEW

fig. 1

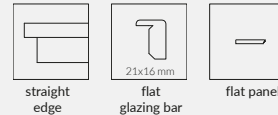

fig. 2

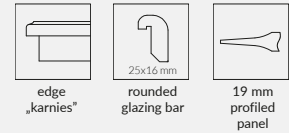

fig. 3

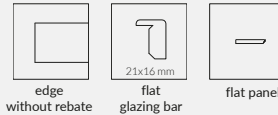
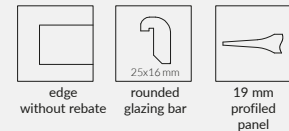

fig. 4



MODERN 10

MODERN 20

MODERN 30

MODERN 40

MODERN 50



CANON 10 - American walnut

Decor DRE-Cell 1	white (structure)	ash	beech	alder	golden oak	calvados	walnut						
Decor DRE-Cell 2	white mat*	white pine	siberian elm	silver	sand oak	bleached oak textured	vintage oak	caramel walnut	golden oak textured	dark walnut textured	gray oak textured***		
	tabac elm	anthracite elm	dark wenge	gray textured	black textured	toffee oak***							
Decor 3D	grand oak	elm	american walnut	ebony	polish oak 3D								

* Decor is not available in door leaf model with "karnies" edge
 *** Decor available only in horizontal wood grain

STANDARD OPTIONS

- » door leaf frame made of softwood
- » core made of „honeycomb“
- » glass pane white bark 4 mm thick

OPTIONS WITHOUT ADDITIONAL CHARGE

- » glass pane „chinchila“ or „window blind“
- » ventilation sleeves
- » three hinges - applies to rebated door leaf

REBATED DOOR LEAF

- » optional: straight edge, flat glazing bar, flat 4 mm HDF panels **fig. 1** or „karnies“ edge, rounded glazing bar, profiled 19 mm MDF panels **fig. 2**
- » 2 silver screw-in pivot hinges
- » single-point mortise lock for simple key, for bathroom lock, for cylinder lock or economic lock

NON-REBATED DOOR LEAF (EXTRA CHARGE)

- » edge without rebate, flat glazing bar, flat 4 mm HDF panels **fig. 3**
- » sockets for 2 hidden concealed Estetic 80 hinges (non-rebated door frames are equipped with hinges)
- » magnetic lock for simple key, for bathroom lock, for cylinder lock or economic lock

SLIDING SYSTEM DOOR LEAF

- » edge without rebate and optional: flat glazing bar, flat 4 mm HDF panels **fig. 3** or rounded glazing bar, profiled 19 mm MDF panels **fig. 4**
- » socket for hook lock and/or for handles

OPTIONS AVAILABLE WITH EXTRA CHARGE

- » glass pane MAT DRE, DECORMAT BROWN, DECORMAT GRAPHITE, (applies to door leaf) KANON 20 KANON 30 KANON 40
- » white frost VSG 22.1 safe, complex glass pane KANON 20 KANON 30 KANON 40
- » core made of perforated chipboard
- » non-rebated door leaf
- » door leaf „90“ and „100“
- » ventilation undercut
- » plastic ventilation grille
- » aluminum ventilation grille
- » cover-up strip for double leaf non-rebated door
- » double leaf door leaf price x2
- » **NOTE:** third hinge Estetic 80 for non-rebated doors (additional payment is added to the price of the door frame)

NEW

fig. 1

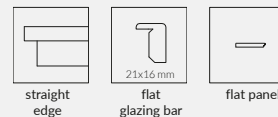

fig. 2

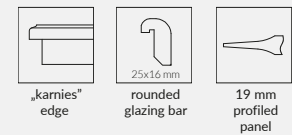

fig. 3

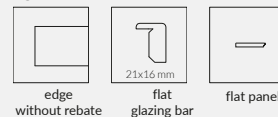
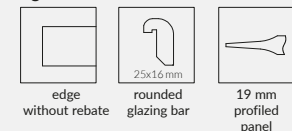

fig. 4



KANON 10

KANON 20

KANON 30

KANON 40



IDEA 30 - gray textured

Decor DRE-Cell 1	white (structure)	ash	beech	alder	golden oak	calvados	walnut						
Decor DRE-Cell 2	white mat*	white pine	siberian elm	silver	sand oak	bleached oak textured	vintage oak	caramel walnut	golden oak textured	dark walnut textured	gray oak textured***		
	tabac elm	anthracite elm	dark wenge	gray textured	black textured	toffee oak***							
Decor 3D	grand oak	elm	american walnut	ebony	polish oak 3D								

* Decor is not available in door leaf model with "karnies" edge
 *** Decor available only in horizontal wood grain

STANDARD OPTIONS

- » door leaf frame made of softwood
- » core made of „honeycomb“
- » glass pane white bark 4 mm thick

OPTION WITHOUT ADDITIONAL CHARGE

- » glass pane „chinchila“ or „window blind“
- » ventilation sleeves
- » three hinges - applies to rebated door leaf

REBATED DOOR LEAF

- » optional: straight edge, flat glazing bar, flat 4 mm HDF panels **fig. 1** or „karnies“ edge, rounded glazing bar, profiled 19 mm MDF panels **fig. 2**
- » 2 silver screw-in pivot hinges
- » single-point mortise lock for simple key, for bathroom lock, for cylinder lock or economic lock

NON-REBATED DOOR LEAF (EXTRA CHARGE)

- » edge without rebate, flat glazing bar, flat 4 mm HDF panels **fig. 3**
- » sockets for 2 hidden concealed Estetic 80 hinges (non-rebated door frames are equipped with hinges)
- » magnetic lock for simple key, for bathroom lock, for cylinder lock or economic lock

SLIDING SYSTEM DOOR LEAF

- » edge without rebate and optional: flat glazing bar, flat 4 mm HDF panels **fig. 3** or rounded glazing bar, profiled 19 mm MDF panels **fig. 4**
- » socket for hook lock and/or for handles

OPTIONS AVAILABLE WITH EXTRA CHARGE

- » glass pane MAT DRE, DECORMAT BROWN, DECORMAT GRAPHITE (applies to door leaf) IDEA 20, 40, 50, 70, 80 IDEA 30, 90, 100, 110, 120 IDEA 60
- » white frost VSG 22.1 safe, complex glass pane IDEA 20 IDEA 30 IDEA 40, 90, 120 IDEA 50, 70 IDEA 60 IDEA 80, 110 IDEA 100
- » core made of perforated chipboard
- » non-rebated door leaf
- » door leaf „90“ and „100“
- » ventilation undercut
- » plastic ventilation grille
- » aluminum ventilation grille
- » cover-up strip for double leaf non-rebated door
- » double leaf door leaf price x2
- » **NOTE:** third hinge Estetic 80 for non-rebated doors (additional payment is added to the price of the door frame)

NEW

fig. 1

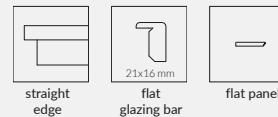

fig. 2

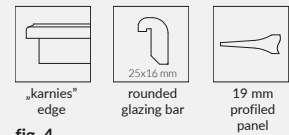

fig. 3

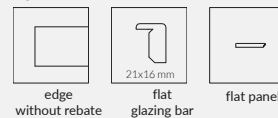
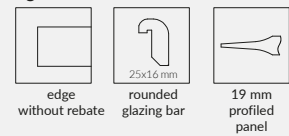

fig. 4





PLUS 30 - white matt

Decor DRE-Cell 1	white (structure)	ash	beech	alder	golden oak	calvados	walnut						
Decor DRE-Cell 2	white matt*	white pine	siberian elm	silver	sand oak	bleached oak textured	vintage oak	caramel walnut	golden oak textured	dark walnut textured	gray oak textured***		
	tabac elm	anthracite elm	dark wenge	gray textured	black textured	toffee oak							
Decor 3D	grand oak	elm	american walnut	ebony	polish oak 3D								

* Decor is not available in door leaf model with "karnies" edge
 *** Decor available only in horizontal wood grain

STANDARD OPTIONS

- » door leaf frame made of softwood
- » core made of „honeycomb“
- » glass pane white bark 4 mm thick

OPTIONS WITHOUT ADDITIONAL CHARGE

- » glass pane „chinchila“ or „window blind“
- » ventilation sleeves
- » three hinges - applies to rebated door leaf

REBATED DOOR LEAF

- » optional: straight edge, flat glazing bar, flat 4 mm HDF panels fig. 1 or „karnies“ edge, rounded glazing bar, flat 4 mm HDF panels fig. 2
- » 2 silver screw-in pivot hinges
- » single-point mortise lock for simple key, for bathroom lock, for cylinder lock or economic lock

NON-REBATED DOOR LEAF (extra charge)

- » edge without rebate, flat glazing bar, flat 4 mm HDF panels fig. 3
- » sockets for 2 hidden concealed Estetic 80 hinges (non-rebated door frames are equipped with hinges)
- » magnetic lock for simple key, for bathroom lock, for cylinder lock or economic lock

SLIDING SYSTEM DOOR LEAF

- » edge without rebate, flat 4 mm HDF panels and optional: flat glazing bar, fig. 3 or rounded glazing bar fig. 4
- » socket for hook lock and/or for handles

OPTIONS AVAILABLE WITH EXTRA CHARGE

- » glass pane MAT DRE, DECORMAT BROWN, DECORMAT GRAPHITE (applies to door leaf) PLUS 20 PLUS 40, 50, 60, 70, 80 PLUS 30
- » white frost VSG 22.1 safe, complex glass pane PLUS 20 PLUS 30 PLUS 40 PLUS 70, 80

NEW

- » core made of perforated chipboard
- » non-rebated door leaf
- » door leaf „90“ and „100“
- » ventilation undercut
- » plastic ventilation grille
- » aluminum ventilation grille
- » cover-up strip for double leaf non-rebated door
- » double leaf door leaf price x2
- » **NOTE:** third hinge Estetic 80 for non-rebated doors (additional payment is added to the price of the door frame)

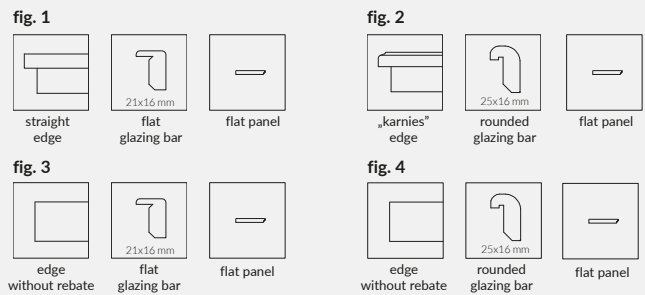



STANDARD 10 and STEEL BULAJ - sand oak

Decor DRE-Cell 1	white (structure)	ash	beech	alder	golden oak	calvados	walnut							
Decor DRE-Cell 2	white mat*	white pine	siberian elm	silver	sand oak	bleached oak textured	vintage oak	caramel walnut	golden oak textured	dark walnut textured	gray oak textured***			
	tabac elm	anthracite elm	dark wenge	gray textured	black textured	toffee oak***								
Decor 3D	grand oak	elm	american walnut	ebony	polish oak 3D									

* Decor is not available in door leaf model with "karnies" edge
 *** Decor available only in horizontal wood grain

STANDARD OPTIONS

- » door leaf frame made of softwood
- » core made of „honeycomb“
- » glass pane white bark 4 mm thick

OPTIONS WITHOUT ADDITIONAL CHARGE

- » glass pane „chinchila“ or „window blind“
- » ventilation sleeves
- » three hinges - applies to rebated door leaf

REBATED DOOR LEAF

- » optional: straight edge, flat glazing bar fig.1 or "karnies" edge, rounded glazing bar, fig. 2
- » 2 silver screw-in pivot hinges
- » single-point mortise lock for simple key, for bathroom lock, for cylinder lock or economic lock
- » **Orders, in investment standard, will be executed after consultations with Untypical Orders Department. By investment standard, is defined door frame passage, with opened door leaf at 90 degree, respectively for doors: interior "80" 800 mm, "90" 900 mm.**

NON-REBATED DOOR LEAF (extra charge)

- » edge without rebate, flat glazing bar fig.3
- » sockets for 2 hidden concealed Estetic 80 hinges (non-rebated door frames are equipped with hinges)
- » magnetic lock for simple key, for bathroom lock, for cylinder lock or economic lock

SLIDING SYSTEM DOOR LEAF

- » edge without rebate and optional: flat glazing bar fig. 3 or rounded glazing bar fig.4
- » socket for hook lock and/or for handles

OPTIONS AVAILABLE WITH EXTRA CHARGE

- » glass pane MAT DRE, DECORMAT BROWN, DECORMAT GRAPHITE (applies to door leaf) STANDARD 20, 20s, 40, 40s, BULAJ MDF
- » STANDARD 50, 50s
- » STANDARD 30, 30s
- » STANDARD 60
- » white frost VSG 22.1 safe, complex glass pane STANDARD 20, 20s, 40, 40s
- » STANDARD 50, 50s, BULAJ MDF
- » STANDARD 30, 30s
- » STANDARD 60
- » core made of perforated chipboard
- » non-rebated door leaf
- » door leaf „90“ and „100“
- » rebated door leaf "110" (only STANDARD 10)
- » additional upper single point mortise lock (available only in STANDARD 10 door leaf model with core made of perforated chipboard and fixed door frame)
- » ventilation undercut
- » plastic ventilation grille
- » aluminum ventilation grille
- » cover-up strip for double leaf non-rebated door
- » double leaf door door leaf price x 2
- » there is possibility to purchase steel bulaj separately
- » **NOTE:** third hinge Estetic 80 for non-rebated doors (additional payment is added to the price of the door frame)

NEW

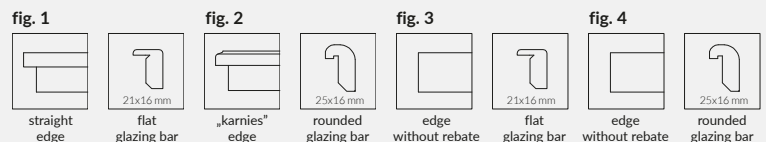

additional upper single point mortise lock (available only in STANDARD 10 door leaf model with core made of perforated chipboard and fixed door frame)



steel BULAJ (available only MAT or transparent glass pane)



RIM 20 - bleached oak textured

Decor DRE-Cell	white (structure)	white mat	white pine	siberian elm	silver	sand oak	bleached oak textured	vintage oak	ash	beech	alder	golden oak	golden oak textured
	calvados	walnut	caramel walnut	dark walnut textured	gray oak textured***	tabac elm	anthracite elm	dark wenge	gray textured	black textured	toffee oak ***		
Decor 3D	grand oak	elm	american walnut	ebony	polish oak 3D								

*** Decor available only in horizontal wood grain

STANDARD OPTIONS

- » reinforced door leaf frame
- » core made of perforated chipboard
- » 8 mm tempered glass - decormat

OPTIONS WITHOUT ADDITIONAL CHARGE

- » glass pane DECORMAT BROWN, DECORMAT GRAPHITE or transparent glass pane
- » ventilation sleeves

REBATED DOOR LEAF

- » straight edge **fig. 1**
- » 3 silver screw-in pivot hinges
- » single-point mortise lock for simple key, for bathroom lock, for cylinder lock or economic lock

NON-REBATED DOOR LEAF RIM 10 AND RIM 20 (EXTRA CHARGE)

- » edge without rebate, **fig. 2**
- » sockets for 2 hidden concealed Estetic 80 hinges (non-rebated door frames are equipped with hinges)
- » magnetic lock for simple key, for bathroom lock, for cylinder lock or economic lock

NOTE: In RIM collection, non-rebated version of door leaf, is only available with models RIM 10 and RIM 20.

* only rebated door leaf

NOTE: It is required to use together with RIM rebated door leaf model door frames equipped with 3 hinges.

OPTIONS AVAILABLE WITH EXTRA CHARGE

- » door leaf "90" and "100"
RIM 10
RIM 20
RIM 30
- » non-rebated door leaf
- » plastic ventilation grille
- » aluminum ventilation grille
- » ventilation undercut
- » NOTE: third hinge Estetic 80 for non-rebated doors (additional payment is added to the price of the door frame)

fig. 1



fig. 2

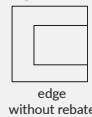

NOTE: Glass panes in RIM collection have obverse and reverse sides. When choosing a reverse version, glass pane is rotated by 180 degree around the vertical axis. Glass pane in RIM models doesn't adhere to gasket.



STANDARD OPTIONS

- » door leaf frame made of softwood
- » core made of „honeycomb“
- » glass pane white bark 4 mm thick

OPTIONS WITHOUT ADDITIONAL CHARGE

- » glass pane „chinchila“ or „window blind“
- » ventilation sleeves
- » three hinges - applies to rebated door leaf

REBATED DOOR LEAF

- » "karnies" edge, rounded glazing bar, profiled 19mm MDF panel **fig. 1**
- » 2 silver screw-in pivot hinges
- » single-point mortise lock for simple key, for bathroom lock, for cylinder lock or economic lock

NON-REBATED DOOR LEAF (EXTRA CHARGE)

- » edge without rebate, flat glazing bar, 19 mm MDF profiled panels **fig. 2**
- » sockets for 2 hidden concealed Estetic 80 hinges (non-rebated door frames are equipped with hinges)
- » magnetic lock for simple key, for bathroom lock, for cylinder lock or economic lock

SLIDING SYSTEM DOOR LEAF

- » edge without rebate, rounded glazing bar or flat glazing bar, profiled 19 mm MDF panel **fig. 3**
- » socket for hook lock and/or for handles

OPTIONS AVAILABLE WITH EXTRA CHARGE

- » glass pane MAT DRE, DECORMAT BROWN, DECORMAT GRAPHITE (applies to door leaf) FANO 20, 20s FANO 30, 30s
- » white frost VSG 22.1 safe, complex glass pane FANO 20, 20s FANO 30, 30s
- » core made of perforated chipboard
- » door leaf „90“ and „100“
- » non-rebated door leaf
- » ventilation undercut
- » plastic ventilation grille
- » aluminum ventilation grille
- » cover-up strip for double leaf non-rebated door
- » double leaf door leaf price x2
- » **NOTE:** third hinge Estetic 80 for non-rebated doors (additional payment is added to the price of the door frame)

NEW

fig. 1

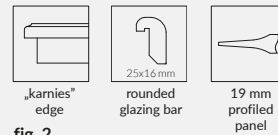

fig. 2

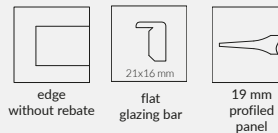
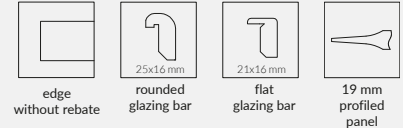

fig. 3



FANO 10

FANO 20

FANO 20s

FANO 30

FANO 30s

Decor DRE-Cell 1	white (structure)	ash	beech	alder	golden oak	calvados	walnut							
	white mat*	white pine	siberian elm	silver	sand oak	bleached oak textured	vintage oak	caramel walnut	golden oak textured	dark walnut textured	gray oak textured***	tabac elm	anthracite elm	dark wenge
Decor DRE-Cell 2	gray textured	black textured	toffee oak***	Decor 3D			grand oak	elm	american walnut	ebony	polish oak 3D			

* Decor is not available in door leaf model with "karnies" edge
*** Decor available only in horizontal wood grain

STANDARD OPTIONS

- » door leaf frame made of softwood
- » core made of „honeycomb“
- » glass pane white bark 4 mm thick

OPTIONS WITHOUT ADDITIONAL CHARGE

- » glass pane „chinchila“ or „window blind“
- » ventilation sleeves
- » three hinges - applies to rebated door leaf

REBATED DOOR LEAF

- » „karnies“ edge, rounded glazing bar **fig. 1**
- » 2 silver screw-in pivot hinges
- » single-point mortise lock for simple key, for bathroom lock, for cylinder lock or economic lock

NON-REBATED DOOR LEAF (EXTRA CHARGE)

- » edge without rebate, flat glazing bar **fig. 2**
- » sockets for 2 hidden concealed Estetic 80 hinges (non-rebated door frames are equipped with hinges)
- » magnetic lock for simple key, for bathroom lock, for cylinder lock or economic lock

SLIDING SYSTEM DOOR LEAF

- » edge without rebate, rounded glazing bar or flat glazing bar **fig. 3**
- » socket for hook lock and/or for handles

OPTIONS AVAILABLE WITH EXTRA CHARGE

- » glass pane MAT DRE, DECORMAT BROWN, DECORMAT GRAPHITE (applies to door leaf) ARTE 10-30, 90 ARTE 40, 50 ARTE 80
- » white frost VSG 22.1 safe, complex glass pane ARTE 10, 20, 30 ARTE 40, 50 ARTE 80 ARTE 90
- » core made of perforated chipboard
- » door leaf „90“ and „100“
- » non-rebated door leaf
- » ventilation undercut
- » plastic ventilation grille
- » aluminum ventilation grille
- » cover-up strip for double leaf non-rebated door
- » double leaf door leaf price x2
- » **NOTE:** third hinge Estetic 80 for non-rebated doors (additional payment is added to the price of the door frame)

NEW

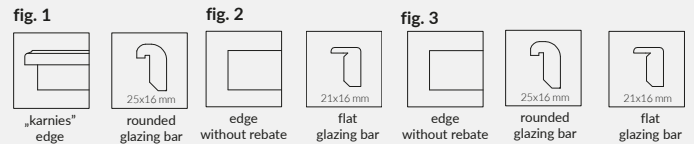

Decor DRE-Cell 1	white (structure)	ash	beech	alder	golden oak	calvados	walnut								
Decor DRE-Cell 2	white mat*	white pine	siberian elm	silver	sand oak	bleached oak textured	vintage oak	caramel walnut	golden oak textured	dark walnut textured	gray oak textured***	tabac elm	anthracite elm	dark wenge	
	gray textured	black textured	toffee oak***	Decor 3D			grand oak	elm	american walnut	ebony	polish oak 3D				

* decor is not available in door leaf model with „karnies“ edge

*** decor available only in horizontal wood grain

STANDARD OPTIONS

- » door leaf frame made of softwood
- » core made of „honeycomb”
- » glass pane white bark 4 mm thick

OPTIONS WITHOUT ADDITIONAL CHARGE

- » glass pane „chinchila” or „window blind”
- » ventilation sleeves
- » three hinges - applies to rebated door leaf

OPTIONS AVAILABLE WITH EXTRA CHARGE

- » glass pane MAT DRE, DECORMAT BROWN, DECORMAT GRAPHITE (applies to door leaf) CLASSIC 20, 20s CLASSIC 30, 30s
- » core made of perforated chipboard
- » door leaf „90” and „100”
- » ventilation undercut
- » plastic ventilation grille
- » aluminum ventilation grille
- » double leaf door

leaf price x2

REBATED DOOR LEAF

- » "karnies" edge, plastic glazing bar **fig. 1**
- » 2 silver screw-in pivot hinges
- » single-point mortise lock for simple key, for bathroom lock, for cylinder lock or economic lock

SLIDING SYSTEM DOOR LEAF

- » edge without rebate, plastic glazing bar **fig. 2**
- » socket for hook lock and/or for handles

fig. 1

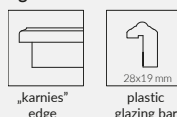
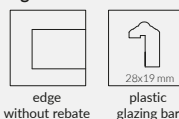
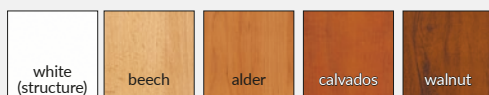

fig. 2



Decor
DRE-Cell



STANDARD OPTIONS

- » door leaf frame made of MDF
- » core made of „honeycomb”
- » lacquered HDF board
- » glass pane MAT DRE 4 mm thick

OPTIONS WITHOUT ADDITIONAL CHARGE

- » ventilation sleeves
- » three hinges - applies to rebated door leaf

REBATED DOOR LEAF

- » optional: „karnies” edge **fig. 1** or straight **fig. 2**
- » rounded glazing bar, flat 4 mm HDF board
- » 2 silver screw-in pivot hinges
- » single-point mortise lock for simple key, for bathroom lock, for cylinder lock or economic lock

NOTE: Due to different manufacturing technology:

- » ASCADA door leaf - lacquered HDF board
 - » door frames, architraves, Finish quarter rounds - which are coated with Finish decor
 - » door leaf edges - edge banding
 - » glazing bars, flat 4 mm HDF boards coated with Finish decor.
- There are colour differences between those elements.

OPTIONS AVAILABLE WITH EXTRA CHARGE

- » door leaf „90” and „100”
- » plastic ventilation grille
- » ventilation undercut

fig. 1



fig. 2

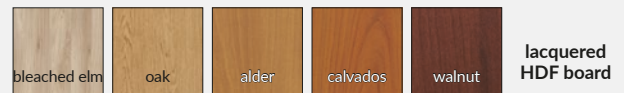
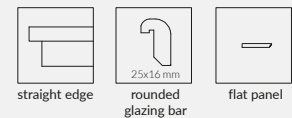

STANDARD OPTIONS

- » door leaf frame made of MDF
- » core made of „honeycomb”
- » lacquered HDF board
- » glass pane white bark 4 mm thick

OPTIONS WITHOUT ADDITIONAL CHARGE

- » glass pane "chinchila"
- » ventilation sleeves
- » three hinges applies to rebated door leaf

REBATED DOOR LEAF

- » optional: "karnies" edge **fig. 1** or straight **fig. 2**
- » rounded glazing bar (LACK 20, 30, 40, 40s, 50, 50s) or plastic glazing bar (LACK 20s, 30s)
- » 2 silver screw-in pivot hinges
- » single-point mortise lock for simple key, for bathroom lock, for cylinder lock or economic lock
- » **Orders, in investment standard, will be executed after consultations with Untypical Orders Department. By investment standard, is defined door frame passage, with opened door leaf at 90 degree, respectively for doors: interior "80" 800 mm, "90" 900 mm.**

fig. 1



fig. 2

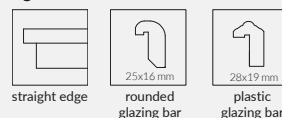

NOTE: Due to different manufacturing technology:

- » door leaf LACK - lacquered HDF board
- » door frames, architraves, Finish quarter rounds - which are coated with Finish decor
- » door leaf edges - edge banding

There are colour differences between those elements.



LACK 10

LACK 20

LACK 20s

LACK 30

LACK 30s

lacquered
HDF board

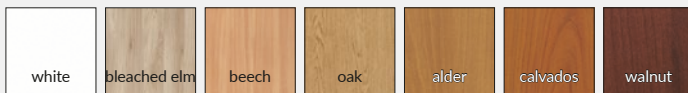

OPTIONS AVAILABLE WITH EXTRA CHARGE

- » glass pane MAT DRE (applies to door leaf)
LACK 20, 20s, 40, 40s
LACK 30, 30s
LACK 50, 50s
- » core made of : perforated chipboard LACK 10
- » door leaf „90” and „100”
- » additional upper single point mortise lock (available only in LACK 10 door leaf model with core made of perforated chipboard and fixed door frame)
- » plastic ventilation grille
- » ventilation undercut

optional:



additional upper single point mortise lock
LACK 10 door leaf model with core made
of perforated chipboard and fixed door
frame.



LACK 40

LACK 40s

LACK 50

LACK 50s

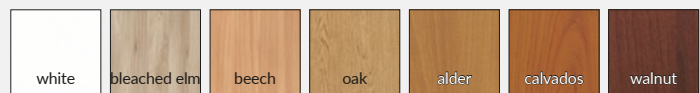

lacquered
HDF board



DUERO natura ALU 60 oak

natural veneer

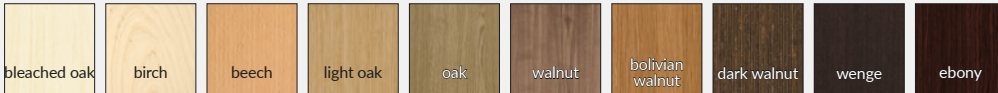

STANDARD OPTIONS

- » door leaf frame made of softwood
- » core made of perforated chipboard
- » natural veneer secured with UV varnish
- » aluminum marquetry elements with cross - section 8X2 mm

OPTIONS WITHOUT ADDITIONAL CHARGE

- » holes for ventilation sleeves
- » three hinges - applies to rebated door leaf

REBATED DOOR LEAF

- » straight edge **fig. 1**
- » 2 silver screw-in pivot hinges
- » single-point mortise lock for simple key, for bathroom lock, for cylinder lock or economic lock

NON-REBATED DOOR LEAF (EXTRA CHARGE)

- » edge without rebate **fig. 2**
- » sockets for 2 hidden concealed Estetic 80 hinges (non-rebated door frames are equipped with hinges)
- » magnetic lock for simple key, for bathroom lock, for cylinder lock or economic lock

SLIDING SYSTEM DOOR LEAF

- » edge without rebate **fig. 2**
- » socket for hook lock and/or for handles

In DUERO Natura ALU there is monochromatic , uniform, horizontal wood grain.

NOTE: The specificity of natural veneer is a possibility of differences in wood grain and staining. These differences can not be the basis of the accepted complaint.

OPTIONS AVAILABLE WITH EXTRA CHARGE

- » door leaf „90” and „100”
- » ventilation undercut
- » non-rebated door leaf
- » cover-up strip for double leaf non-rebated door
- » double leaf door leaf price x2
- » **NOTE:** third hinge Estetic 80 for non-rebated doors (additional payment is added to the price of the door frame)

fig. 1



straight edge

fig. 2



edge without rebate

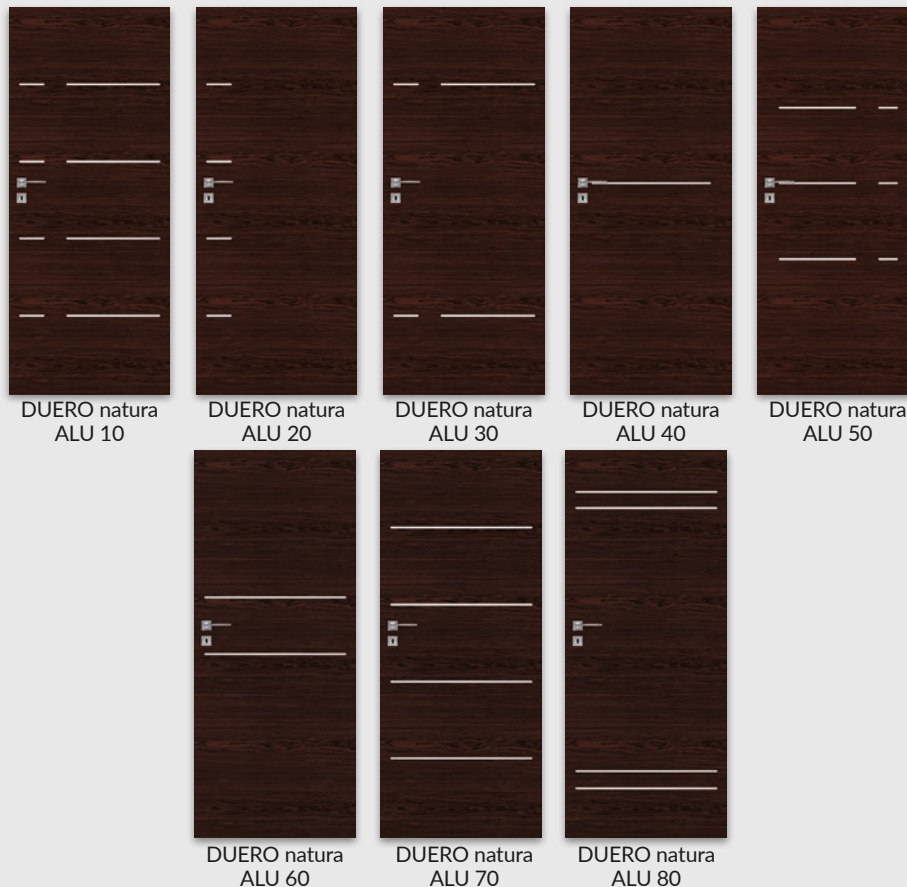

DUERO natura
ALU 10

DUERO natura
ALU 20

DUERO natura
ALU 30

DUERO natura
ALU 40

DUERO natura
ALU 50

DUERO natura
ALU 60

DUERO natura
ALU 70

DUERO natura
ALU 80



ARTE natura 90 - birch

natural veneer 1	 birch	 beech	 oak		
natural veneer 2	 walnut	 wenge			
natural veneer 3	 bleached oak	 light oak	 bolivian walnut	 dark walnut	 ebony

STANDARD OPTIONS

- » door leaf frame made of softwood
- » core made of „honeycomb“
- » natural veneer secured with UV varnish
- » 4 mm glass pane "window blind"

OPTIONS WITHOUT ADDITIONAL CHARGE

- » glass pane "chinchila" or "white bark"
- » holes for ventilation sleeves
- » three hinges - applies to rebated door leaf

REBATED DOOR LEAF

- » straight edge, rounded glazing bar **fig. 1**
- » 2 silver screw-in pivot hinges
- » single-point mortise lock for simple key, for bathroom lock, for cylinder lock or economic lock

NON-REBATED DOOR LEAF (EXTRA CHARGE)

- » edge without rebate, rounded glazing bar **fig. 2**
- » sockets for 2 hidden concealed Estetic 80 hinges (non-rebated door frames are equipped with hinges)
- » magnetic lock for simple key, for bathroom lock, for cylinder lock or economic lock

SLIDING SYSTEM DOOR LEAF

- » edge without rebate, rounded glazing bar **fig. 2**
- » socket for hook lock and/or for handles

NOTE: The specificity of natural veneer is a possibility of differences in wood grain and staining. These differences can not be the basis of the accepted complaint..

OPTIONS AVAILABLE WITH EXTRA CHARGE

- » glass pane MAT DRE or DECORMAT BROWN (applies to door leaf)
 - ARTE natura 10, 20, 30, 90
 - ARTE natura 40, 50
 - ARTE natura 80
- » white frost VSG 22.1 safe, complex glass pane NEW
 - ARTE natura 10, 20, 30
 - ARTE natura 40, 50
 - ARTE natura 80
 - ARTE natura 90
- » core made of perforated chipboard
 - » door leaf „90“ and „100“
 - » ventilation undercut
 - » plastic ventilation grille
 - » aluminum ventilation grille
 - » non-rebated door leaf
 - » cover-up strip for double leaf non-rebated door
 - » double leaf door leaf price x2
 - » **NOTE:** third hinge Estetic 80 for non-rebated doors (additional payment is added to the price of the door frame)

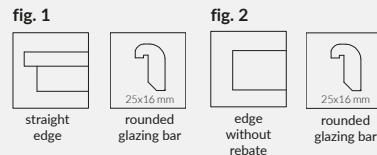

STANDARD OPTIONS

- » door leaf frame made of softwood
- » core made of „honeycomb“
- » natural veneer secured with UV varnish
- » 4 mm glass pane "window blind"

OPTIONS WITHOUT ADDITIONAL CHARGE

- » glass pane "chinchila" or "white bark"
- » holes for ventilation sleeves
- » three hinges - applies to rebated door leaf

NOTE: The specificity of natural veneer is a possibility of differences in wood grain and staining. These differences can not be the basis of the accepted complaint.

REBATED DOOR LEAF

- » straight edge, rounded glazing bar **fig. 1**
- » 2 silver screw-in pivot hinges
- » single-point mortise lock for simple key, for bathroom lock, for cylinder lock or economic lock

NON-REBATED DOOR LEAF (EXTRA CHARGE)

- » edge without rebate, rounded glazing bar **fig. 2**
- » sockets for 2 hidden concealed Estetic 80 hinges (non-rebated door frames are equipped with hinges)
- » magnetic lock for simple key, for bathroom lock, for cylinder lock or economic lock

SLIDING SYSTEM DOOR LEAF

- » edge without rebate, rounded glazing bar **fig. 2**
- » socket for hook lock and/or for handles

fig. 1

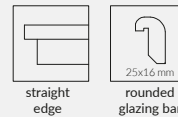
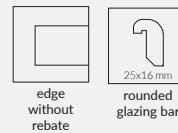

fig. 2



natural veneer 1	birch	beech	oak	walnut	wenge
natural veneer 2	bleached oak	light oak	bolivian walnut	dark walnut	ebony

OPTIONS AVAILABLE WITH EXTRA CHARGE

- » glass pane MAT DRE, DECORMAT BROWN or DECORMAT GRAPHITE (applies to door leaf)
STANDARD natura 20, 20s, 40, 40s, BULAJ natura MDF
STANDARD natura 30, 30s
STANDARD natura 50, 50s
STANDARD natura 60
- » white frost VSG 22.1 safe, complex glass pane
STANDARD natura 20, 20s, 40, 40s
STANDARD natura 50, 50s, BULAJ MDF
STANDARD natura 30, 30s
STANDARD natura 60
- » core made of perforated chipboard
- » door leaf „90” and „100”
- » rebated door leaf "110" (only STANDARD natura 10)
- » ventilation undercut
- » additional upper lock point mortise lock (A) (available only in STANDARD 10 door leaf model with core made of perforated chipboard and fixed door frame)
- » plastic ventilation grille
- » aluminum ventilation grille
- » non-rebated door leaf
- » cover-up strip for double leaf non-rebated door
- » double leaf door leaf price x2
- » there is possibility to purchase BULAJ separately
- » **NOTE:** third hinge Estetic 80 for non-rebated doors (additional payment is added to the price of the door frame)

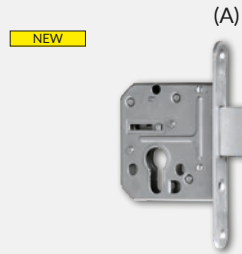

Additional upper lock (A) (available only in STANDARD natura 10 door leaf model with core made of perforated chipboard and fixed door frame)



steel BULAJ (available only MAT or transparent glass pane)



STANDARD natura 40s

STANDARD natura 50

STANDARD natura 50s

STANDARD natura 60

BULAJ natura MDF

BULAJ natura steel

birch	beech	oak	walnut	wenge	natural veneer 1
bleached oak	light oak	bolivian walnut	dark walnut	ebony	
					natural veneer 2

STANDARD OPTIONS

- » door leaf frame made of softwood
- » core made of perforated chipboard
- » natural veneer secured with UV varnish
- » 4 mm glass pane MAT DRE (in models 11,12,21,22,23,51)

OPTIONS WITHOUT ADDITIONAL CHARGE

- » glass pane "window blind" or decormat brown
- » holes for ventilation sleeves
- » three hinges - applies to rebated door leaf

REBATED DOOR LEAF

- » straight edge, rounded glazing bar, **fig. 1**
- » 2 silver screw-in pivot hinges
- » single-point mortise lock for simple key, for bathroom lock, for cylinder lock or economic lock

NON-REBATED DOOR LEAF (EXTRA CHARGE)

- » edge without rebate, rounded glazing bar **fig. 2**
- » sockets for 2 hidden concealed Estetic 80 hinges (non-rebated door frames are equipped with hinges)
- » magnetic lock for simple key, for bathroom lock, for cylinder lock or economic lock

SLIDING SYSTEM DOOR LEAF

- » edge without rebate, rounded glazing bar **fig. 2**
- » socket for hook lock and/or for handles

OPTIONS AVAILABLE WITH EXTRA CHARGE

- » white frost VSG 22.1 safe, complex glass pane NEW
- GALERIA natura 11
- GALERIA natura 23, 51
- GALERIA natura 21
- GALERIA natura 12
- GALERIA natura 22
- » door leaf „90” and „100”
- » ventilation undercut
- » plastic ventilation grille
- » aluminum ventilation grille
- » non-rebated door leaf
- » cover-up strip for double leaf non-rebated door
- » double leaf door leaf price x2
- » **NOTE:** third hinge Estetic 80 for non-rebated doors (additional payment is added to the price of the door frame)

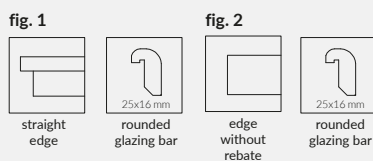

natural veneer

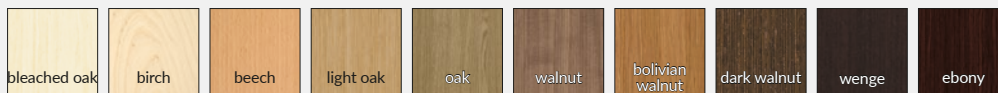

GALERIA Natura passive door leaf 20, 21, 22, 23, are made without horizontal marquetrys, and they are coated with uniform wood grain.

In sliding version of double leaf door GALERIA natura 20, 21, 22, 23, there might be noted differences in the relative positions of horizontal stripes at the corresponding heights of the door leaf.

Door leaf coated with dark natural veneer have stripes in birch colour. Door leaf coated with light natural veneer have stripes in wenge colour.

NOTE: The specificity of natural veneer is a possibility of differences in wood grain and staining. These differences can not be the basis of the accepted complaint.



GALERIA natura 11

GALERIA natura 12

GALERIA natura 21

GALERIA natura 22

GALERIA natura 23

GALERIA natura 51

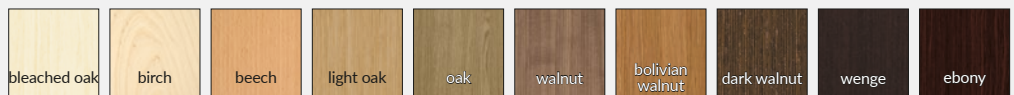

natural veneer

GALERIA natura ALU

REBATED AND NON-REBATED DOOR LEAVES
interior door leaves



STANDARD OPTIONS

- » door leaf frame made of softwood
- » core made of perforated chipboard
- » natural veneer secured with UV varnish
- » aluminum marquetry elements with cross-section 8 x 2 mm
- » 4 mm glass pane MAT DRE (available in models 11-13 and 21-25)

OPTIONS WITHOUT ADDITIONAL CHARGE

- » glass pane "window blind" or decormat brown
- » holes for ventilation sleeves
- » three hinges - applies to rebated door leaf

REBATED DOOR LEAF

- » straight edge, rounded glazing bar, **fig. 1**
- » 2 silver screw-in pivot hinges
- » single-point mortise lock for simple key, for bathroom lock, for cylinder lock or economic lock

NON-REBATED DOOR LEAF (EXTRA CHARGE)

- » edge without rebate, rounded glazing bar **fig. 2**
- » sockets for 2 hidden concealed Estetic 80 hinges (non-rebated door frames are equipped with hinges)
- » magnetic lock for simple key, for bathroom lock, for cylinder lock or economic lock

SLIDING SYSTEM DOOR LEAF

- » edge without rebate, rounded glazing bar **fig. 2**
- » socket for hook lock and/or for handles

OPTIONS AVAILABLE WITH EXTRA CHARGE

- » white frost VSG 22.1 safe, complex glass pane NEW
- GALERIA ALU 11
- GALERIA ALU 13, 23
- GALERIA ALU 21
- GALERIA ALU 24
- GALERIA ALU 25
- GALERIA ALU 12
- GALERIA ALU 22
- » door leaf „90” and „100”
- » ventilation undercut
- » non-rebated door leaf
- » cover-up strip for double leaf non-rebated door
- » double leaf door leaf price x2
- » **NOTE:** third hinge Estetic 80 for non-rebated doors (additional payment is added to the price of the door frame)

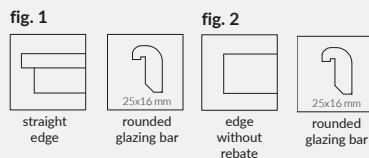

natural veneer

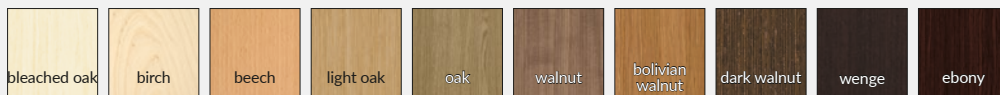

Galeria Natura Alu are coated with veneer in uniform, monochromatic wood grain.

GALERIA Natura Alu passive door leaf 20, 21, 22, 23, 24, 25 and 60 are made without horizontal marquetry, and they are coated with uniform wood grain.

In sliding version of double leaf door GALERIA Natura Alu .20, 21, 22, 23, 24, 25 i 60, there might be noted differences in the relative positions of horizontal stripes at the corresponding heights of the door leaf.

NOTE: The specificity of natural veneer is a possibility of differences in wood grain and staining. These differences can not be the basis of the accepted complaint.

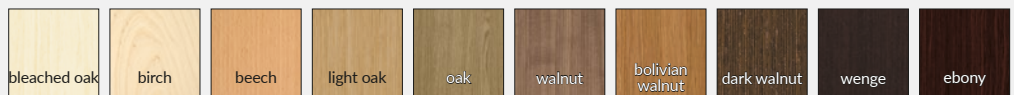
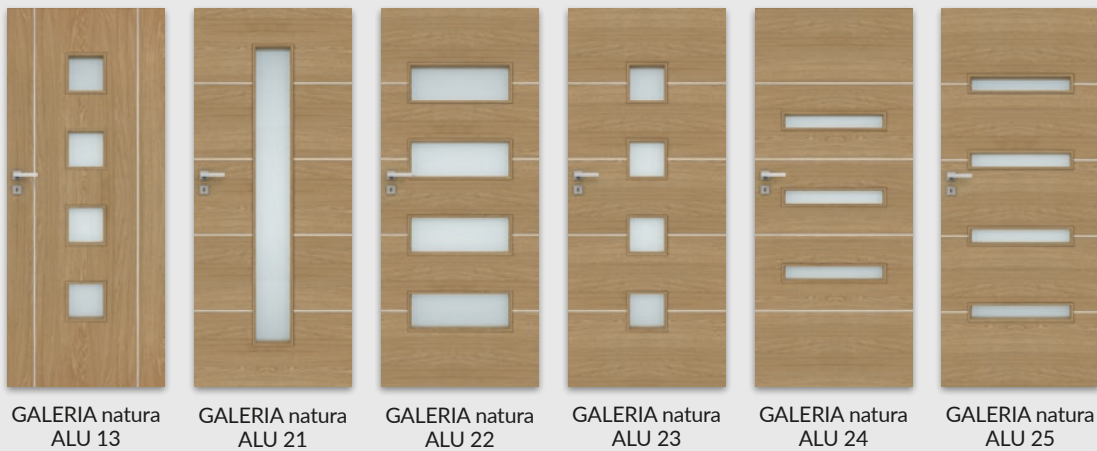

natural veneer



DUO 10 - white/ ebony

Decor



white
lacquered
surface of the
door leaf

Decor
DRE-Cell



sand oak

golden oak

walnut

Decor 3D



polish oak
3D

ebony

STANDARD OPTIONS

- » Door leaf surface painted with white acrylic varnish with strengthened resistance to abrasion
- » door leaf frame made of MDF
- » core made of „honeycomb“
- » glass pane MAT DRE 4 mm thick

OPTIONS WITHOUT ADDITIONAL CHARGE

- » white ventilation sleeves
- » three hinges applies to rebated door leaf

OPTIONS AVAILABLE WITH EXTRA CHARGE

- » white frost VSG 22.1 safe, complex glass pane
DUO 20, 20s
DUO 30, 30s
- » core made of perforated chipboard
- » door leaf „90“ and „100“
- » ventilation undercut
- » plastic ventilation grille

NEW

REBATED DOOR LEAF

- » "karnies" edge, rounded glazing bar fig.1
- » 2 silver screw-in pivot hinges
- » single-point mortise lock for simple key, for bathroom lock, for cylinder lock or economic lock

NOTE: Door leaf surface is painted in white, selected colour applies to glazing bars and door leaf edge. It is recommended to order door frame in this selected colour.

fig. 1

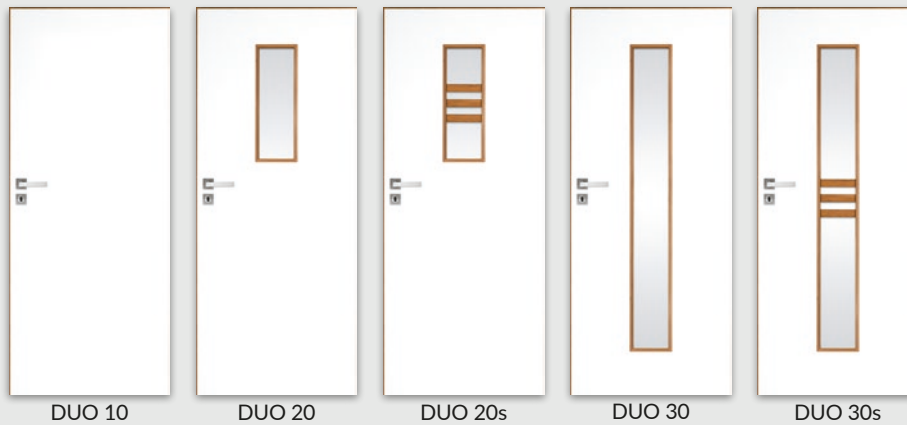
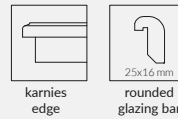



UNI 10 - ashen

Decor



white acrylic UV varnish - RAL 9003
 ecru - RAL 9001
 latte - Flugger 4362, NCS S1505-Y50R
 ashen - RAL 7035

STANDARD OPTIONS

- » door leaf painted with acrylic UV varnish
- » door leaf frame made of softwood
- » core made of „honeycomb“
- » glass pane white bark 4 mm thick

OPTIONS WITHOUT ADDITIONAL CHARGE

- » glass pane „chinchila“ or „window blind“
- » ventilation sleeves
- » three hinges - applies to rebated door leaf

REBATED DOOR LEAF

- » straight edge **fig. 1**
- » 2 silver screw-in pivot hinges
- » single-point mortise lock for simple key, for bathroom lock, for cylinder lock or economic lock

NON-REBATED DOOR LEAF (extra charge)

- » edge without rebate **fig. 2**
- » sockets for 2 hidden concealed Estetic 80 hinges (non-rebated door frames are equipped with hinges)
- » magnetic lock for simple key, for bathroom lock, for cylinder lock or economic lock

SLIDING SYSTEM DOOR LEAF

- » edge without rebate **fig. 2**
- » socket for hook lock and/or for handles

DOOR LEAF WITH INVERTED REBATE

- » active single door leaf
- » straight edge **fig 3**
- » sockets for 2 hidden concealed Tectus 240 3D hinges (door frames are equipped with hinges)
- » magnetic lock for simple key, for bathroom lock, for cylinder lock or economic lock

OPTIONS AVAILABLE WITH EXTRA CHARGE

- » glass pane MAT DRE, DECORMAT BROWN, DECORMAT GRAPHITE (applies to door leaf BULAJ MDF)
- » white frost VSG 22.1 safe, complex glass pane BULAJ MDF NEW
- » core made of perforated chipboard
- » door leaf „90“ and „100“
- » ventilation undercut
- » non-rebated door leaf
- » door leaf with inverted rebate NEW
- » cover-up strip for double leaf non-rebated door
- » plastic ventilation grille
- » aluminum ventilation grille
- » double leaf door leaf price x2
- » there is possibility to purchase steel BULAJ separately
- » **NOTE:** third hinge Estetic 80 for non-rebated doors (additional payment is added to the price of the door frame)

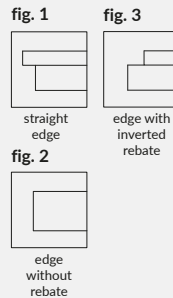

steel BULAJ
(available only MAT or transparent glass pane)

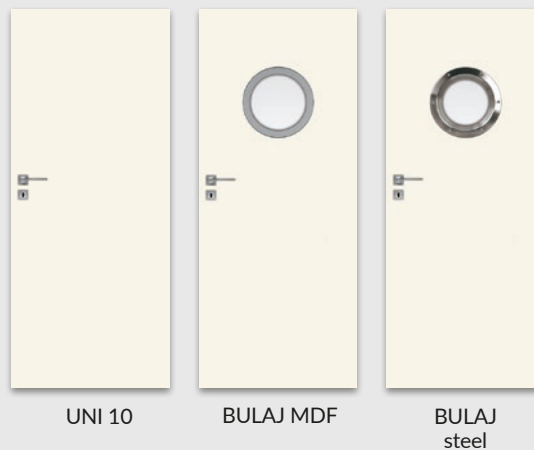



FARGO 10 - ashen

Decor



white acrylic UV varnish - RAL 9003
 ecru - RAL 9001
 latte - Flugger 4362, NCS S1505-Y50R
 ashen - RAL 7035



STANDARD OPTIONS

- » door leaf painted with acrylic UV varnish
- » door leaf frame made of softwood
- » core made of „honeycomb”

OPTIONS WITHOUT ADDITIONAL CHARGE

- » ventilation sleeves
- » three hinges - applies to rebated door leaf

NOTE: To ensure highest quality of painted products, before painting process, both, door leaf and door frames are coated with special material which constitutes solid base.

REBATED DOOR LEAF

- » straight edge **fig. 1**
- » 2 silver screw-in pivot hinges
- » single-point mortise lock for simple key, for bathroom lock, for cylinder lock or economic lock

NON-REBATED DOOR LEAF (extra charge)

- » edge without rebate **fig. 2**
- » sockets for 2 hidden concealed Estetic 80 hinges (non-rebated door frames are equipped with hinges)
- » magnetic lock for simple key, for bathroom lock, for cylinder lock or economic lock

SLIDING SYSTEM DOOR LEAF

- » edge without rebate **fig. 2**
- » socket for hook lock and/or for handles

DOOR LEAF WITH INVERTED REBATE

- » active single door leaf
- » straight edge **fig 3**
- » sockets for 2 hidden concealed Tectus 240 3D hinges (door frames are equipped with hinges)
- » magnetic lock for simple key, for bathroom lock, for cylinder lock or economic lock

OPTIONS AVAILABLE WITH EXTRA CHARGE

- » door leaf „90” and „100”
- » core made of perforated chipboard
- » ventilation undercut
- » non-rebated door leaf
- » door leaf with inverted rebate
- » cover-up strip for double leaf non-rebated door
- » plastic ventilation grille
- » aluminum ventilation grille
- » double leaf door leaf price x2
- » **NOTE:** third hinge Estetic 80 for non-rebated doors (additional payment is added to the price of the door frame)

NEW

fig. 1



straight edge

fig. 2



edge without rebate

fig. 3



edge with inverted rebate



type of the milling in FARGO collection





BINITO 21 white acrylic UV varnish

Decor



white acrylic UV varnish - RAL 9003
 ecru - RAL 9001
 latte - Flugger 4362, NCS S1505-Y50R
 ashen - RAL 7035



types of milling in BINITO collection

STANDARD OPTIONS

- » door leaf painted with acrylic UV varnish
- » door leaf frame made of softwood
- » core made of „honeycomb”
- » glass pane white bark 4 mm thick

OPTIONS WITHOUT ADDITIONAL CHARGE

- » glass pane „chinchila” or „window blind”
- » ventilation sleeves
- » three hinges - applies to rebated door leaf

NOTE: To ensure highest quality of painted products, before painting process, both, door leaf and door frames are coated with special material which constitutes solid base.

REBATED DOOR LEAF

- » straight edge, flat glazing bar **fig. 1**
- » 2 silver screw-in pivot hinges
- » single-point mortise lock for simple key, for bathroom lock, for cylinder lock or economic lock

NON-REBATED DOOR LEAF (extra charge)

- » edge without rebate, flat glazing bar **fig. 2**
- » sockets for 2 hidden concealed Estetic 80 hinges (non-rebated door frames are equipped with hinges)
- » magnetic lock for simple key, for bathroom lock, for cylinder lock or economic lock

SLIDING SYSTEM DOOR LEAF

- » edge without rebate, flat glazing bar **fig. 2**
- » socket for hook lock and/or for handles

DOOR LEAF WITH INVERTED REBATE

- » active single door leaf
- » straight edge **fig 3**
- » sockets for 2 hidden concealed Tectus 240 3D hinges (door frames are equipped with hinges)
- » magnetic lock for simple key, for bathroom lock, for cylinder lock or economic lock

OPTIONS AVAILABLE WITH EXTRA CHARGE

- » glass pane MAT DRE, DECORMAT BROWN, DECORMAT GRAPHITE BINITO 11, 23
- BINITO 21, 100
- BINITO 24, 110
- » white frost VSG 22.1 safe, complex glass pane
- BINITO 11
- BINITO 23
- BINITO 21, 100
- BINITO 24
- BINITO 110
- » door leaf „90” and „100”
- » core made of perforated chipboard
- » ventilation undercut
- » non-rebated door leaf
- » door leaf with inverted rebate
- » cover-up strip for double leaf non-rebated door
- » plastic ventilation grille
- » aluminum ventilation grille
- » double leaf door leaf price x2
- » **NOTE:** third hinge Estetic 80 for non-rebated doors (additional payment is added to the price of the door frame)

NEW

NEW

fig. 1

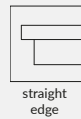

fig. 2

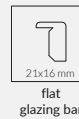

fig. 2



fig. 3



fig. 3

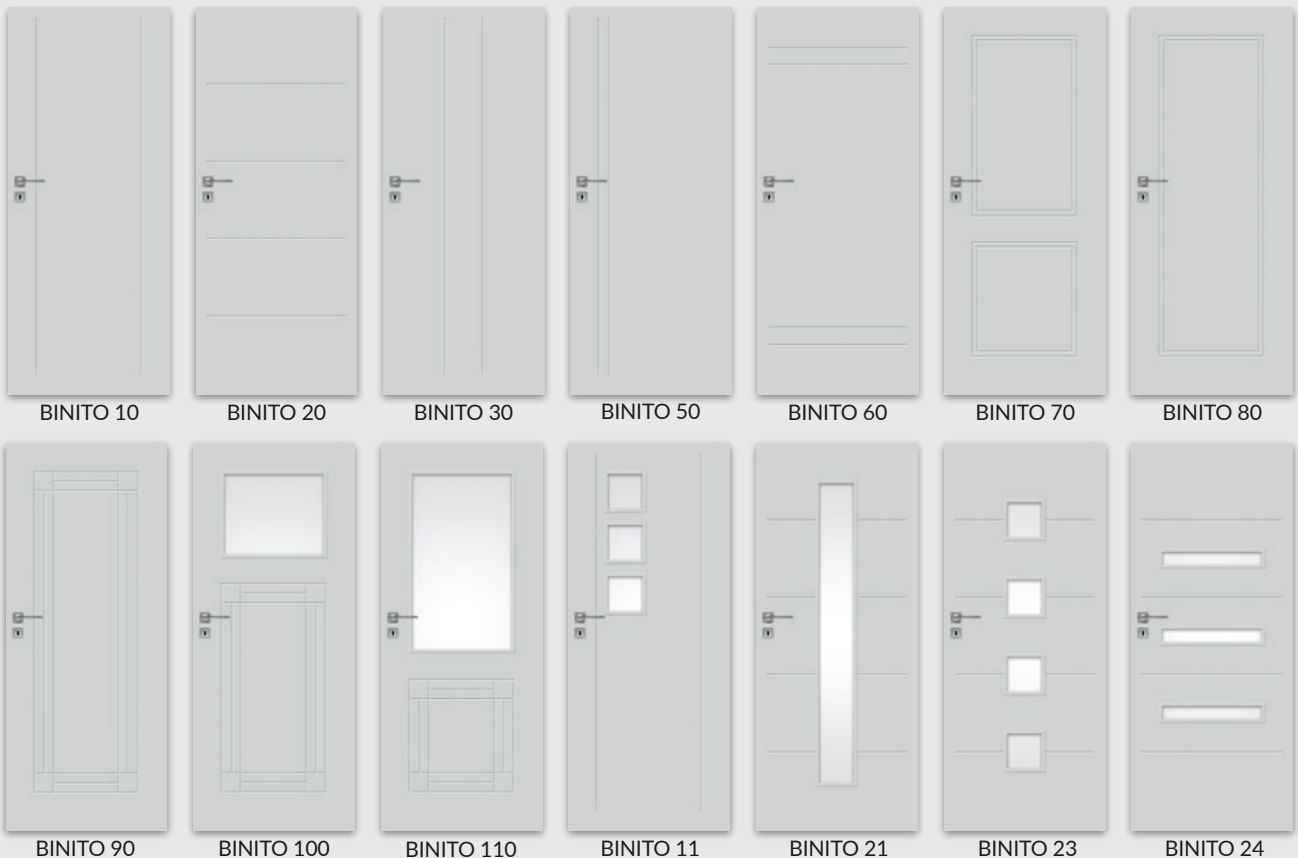
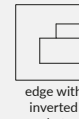

STANDARD OPTIONS

- » edge with radius R 2,5 mm
- » door leaf frame made of softwood
- » core made of „honeycomb“
- » glass pane white bark 4 mm thick
- » CPL laminate 0,15 - 0,2 mm or 0,7 - 0,8 mm thick

OPTIONS WITHOUT ADDITIONAL CHARGE

- » glass pane „chinchila“ or „window blind“
- » ventilation sleeves
- » three hinges - applies to rebated door leaf

REBATED DOOR LEAF

- » straight edge coated with edge band 1,5 mm thick or edge with radius R 2,5 mm finished with method of directforming **fig. 1**
- » 2 silver screw-in pivot hinges
- » single-point mortise lock for simple key, for bathroom lock, for cylinder lock or economic lock
- » **Orders, in investment standard, will be executed after consultations with Untypical Orders Department. By investment standard, is defined door frame passage, with opened door leaf at 90 degree, respectively for doors: interior "80" 800 mm, "90" 900 mm.**

NON-REBATED DOOR LEAF (extra charge)

- » edge without rebate, rounded glazing bar **fig. 2**
- » sockets for 2 hidden concealed Estetic 80 hinges (non-rebated door frames are equipped with hinges)
- » magnetic lock for simple key, for bathroom lock, for cylinder lock or economic lock

SLIDING SYSTEM DOOR LEAF

- » edge without rebate, rounded glazing bar **fig. 2**
- » socket for hook lock and/or for handles

NOTE: colours equivalent: W0118 - WHITE LIGHT GRAY; RAL=7047

OPTIONS AVAILABLE WITH EXTRA CHARGE

- » straight edge and edge without rebate in CPL laminate is coated with edgeband 1,5 mm thick
- » glass pane MAT DRE, DECORMAT BROWN, DECORMAT GRAPHITE (applies to door leaf) STANDARD 20, BULAJ MDF STANDARD 60
- » white frost VSG 22.1 safe, complex glass pane STANDARD 20 **NEW**
STANDARD 60
BULAJ MDF
- » core made of perforated chipboard
- » door leaf „90“ and „100“
- » door leaf "110" (available only in STANDARD 10)
- » non-rebated door leaf
- » Additional upper single point mortise lock (available only in STANDARD 10 door leaf model with core made of perforated chipboard and fixed door frame)
- » plastic ventilation grille
- » aluminum ventilation grille
- » cover-up strip for double leaf non-rebated door
- » ventilation undercut
- » double leaf door leaf price x2
- » there is possibility to purchase BULAJ separately
- » **NOTE: third hinge Estetic 80 for non-rebated doors (additional payment is added to the price of the door frame)**

There is available 0,7 - 0,8 mm CPL laminate- to place an order and for more information please contact Customer Service Department.

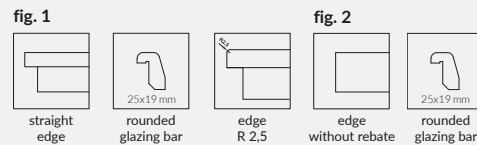

CPL Laminate

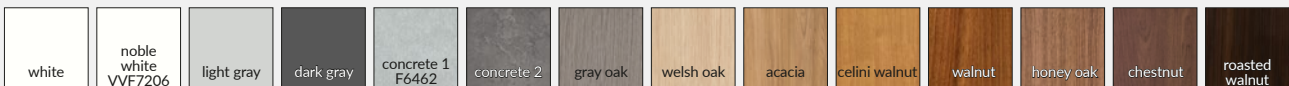

STANDARD OPTIONS

- » door leaf frame made of softwood
- » core made of „honeycomb“

OPTIONS WITHOUT ADDITIONAL CHARGE

- » ventilation sleeves

REBATED DOOR LEAF

- » straight edge coated with edge banding or edge with profile R2,5 mm made in method of directforming **fig. 1**
- » 3 silver screw-in pivot hinges
- » single-point mortise lock for simple key, for bathroom lock, for cylinder lock or economic lock

NON-REBATED DOOR LEAF (extra charge)

- » edge without rebate **fig. 2**
- » sockets for 2 hidden concealed Estetic 80 hinges (non-rebated door frames are equipped with hinges)
- » magnetic lock for simple key, for bathroom lock, for cylinder lock or economic lock

OPTIONS AVAILABLE WITH EXTRA CHARGE

- » straight edge and edge without rebate in CPL laminate is coated with edgeband 1,5 mm thick
- » core made of: perforated chipboard (1983)
- » core made of perforated chipboard (2110 and 2240)
- » door leaf "90" and "100" (1983)
- » door leaf "90" and "100" (2110 and 2240)
- » non-rebated door leaf
- » ventilation undercut
- » plastic ventilation grille
- » aluminum ventilation grille
- » cover-up strip for double leaf non-rebated door
- » double leaf door leaf price x2
- » **NOTE:** third hinge Estetic 80 for non-rebated doors (additional payment is added to the price of the door frame)

There is available 0,7 - 0,8 mm CPL laminate- to place an order and for more information please contact Customer Service Department.

Door leaf, dependent on selected height option - 1983 mm, 2110 mm or 2240 mm is dedicated to door frames with three hinges in corresponding heights.

NOTE: colours equivalent: W0118 - WHITE LIGHT GRAY; RAL=7047

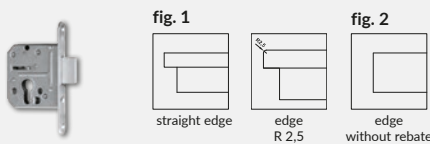

additional upper single point mortise lock (available only in STANDARD 10 door leaf model with core made of perforated chipboard and fixed door frame)

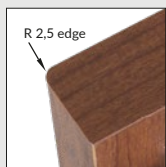

edge R 2,5 mm in CPL laminate



white (structure)	ash	beech	alder	golden oak	calvados	walnut	Decor DRE-Cell 1					gray textured	black textured	toffee oak ***	Decor DRE-Cell 2
white mat	white pine	siberian elm	silver	sand oak	bleached oak textured	vintage oak	walnut caramel	golden oak textured	dark walnut textured	gray oak textured***	tabac elm	anthracite elm	dark wenge	Decor DRE-Cell 2	
white	noble white VVF7206	light gray	gray dark	concrete 1 F6462	concrete 2	gray oak	welsh oak	acacia	celini walnut	walnut	honey oak	chestnut	roasted walnut	CPL Laminate	

*** Decor available only in horizontal wood grain

MODERN

REBATED AND NON-REBATED DOOR LEAVES WITH DIFFERENT HEIGHT
interior door leaves



STANDARD OPTIONS

- » door leaf frame made of softwood
- » core made of „honeycomb”
- » glass pane white bark 4 mm thick

OPTIONS WITHOUT ADDITIONAL CHARGE

- » glass pane „chinchila” or „window blind”
- » ventilation sleeves

REBATED DOOR LEAF

- » straight edge, flat glazing bar (in CPL laminate - rounded glazing bar) flat 4 mm HDF panels **fig. 1**
- » 3 silver screw-in pivot hinges
- » single-point mortise lock for simple key, for bathroom lock, for cylinder lock or economic lock

NON-REBATED DOOR LEAF (EXTRA CHARGE)

- » edge without rebate, flat glazing bar (in CPL - rounded glazing bar), flat 4 mm HDF panels **fig. 2**
- » sockets for 2 hidden concealed Estetic 80 hinges (non-rebated door frames are equipped with hinges)
- » magnetic lock for simple key, for bathroom lock, for cylinder lock or economic lock

NOTE: colours equivalent: W0118 - WHITE LIGHT GRAY; RAL=7047

NOTE: In rebated door leaf coated with CPL laminate it is possible to choose door leaf with edge with radius R=2.5 mm..

NOTE: Different heights are available in all models of MODERN collection.

Door leaf, dependent on selected height option - 1983 mm, 2110 mm or 2240 mm is dedicated to door frames with three hinges in corresponding heights.

OPTIONS AVAILABLE WITH EXTRA CHARGE

- » straight edge and edge without rebate in CPL laminate is coated with edgeband 1,5 mm thick
- » glass pane MAT DRE, DECORMAT BROWN, DECORMAT GRAPHITE (applies to door leaf) MODERN 20 MODERN 30 MODERN 40 MODERN 50
- » white frost VSG 22.1 safe, complex glass pane p. 75

NEW

- » core made of: perforated chipboard (1983 and 2043) core made of perforated chipboard (2110 and 2240)
- » door leaf „90” and „100” (1983 and 2043)
- » door leaf "90" and "100" (2110 and 2240)
- » non-rebated door leaf
- » ventilation undercut
- » plastic ventilation grille
- » aluminum ventilation grille
- » cover-up strip for double leaf non-rebated door
- » double leaf door leaf price x2
- » NOTE: third hinge Estetic 80 for non-rebated doors (additional payment is added to the price of the door frame)

NOTE: collection MODERN 10-50 coated with CPL laminate in standard height is available in sliding version.

fig. 1

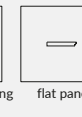
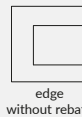

fig. 2



Decor DRE-Cell 1	white (structure)	ash	beech	alder	golden oak	calvados	walnut	Decor DRE-Cell 2						
								gray textured	black textured	toffee oak ***				
Decor DRE-Cell 2	white mat	white pine	siberian elm	silver	sand oak	bleached oak textured	vintage oak	caramel walnut	golden oak textured	dark walnut textured	gray oak textured**	elm tabac	anthracite elm	dark wenge
CPL Laminate	white	noble white VVF7206	light gray	gray dark	concrete 1 F6462	concrete 2	gray oak	welsh oak	acacia	celini walnut	walnut	honey oak	chestnut	roasted walnut

*** decor available only in horizontal wood grain

STANDARD OPTIONS

- » door leaf frame made of softwood
- » core made of „honeycomb”
- » glass pane white bark 4 mm thick

OPTIONS WITHOUT ADDITIONAL CHARGE

- » glass pane „chinchila” or „window blind”
- » ventilation sleeves

REBATED DOOR LEAF

- » straight edge, flat glazing bar (in CPL laminate - rounded glazing bar) flat 4 mm HDF panels **fig. 1**
- » 3 silver screw-in pivot hinges
- » single-point mortise lock for simple key, for bathroom lock, for cylinder lock or economic lock

NON-REBATED DOOR LEAF (extra charge)

- » edge without rebate, flat glazing bar (in CPL laminate - rounded glazing bar), flat 4mm HDF panels **fig. 2**
- » sockets for 2 hidden concealed Estetic 80 hinges (non-rebated door frames are equipped with hinges)
- » magnetic lock for simple key, for bathroom lock, for cylinder lock or economic lock

NOTE: colours equivalent: W0118 - WHITE LIGHT GRAY; RAL=7047

NOTE: In rebated door leaf coated with CPL laminate it is possible to choose door leaf with edge with radius R=2.5 mm..

NOTE: Different heights are available in all models of PLUS collection.

Door leaf, dependent on selected height option - 1983 mm, 2110 mm or 2240 mm is dedicated to door frames with three hinges in corresponding heights.

OPTIONS AVAILABLE WITH EXTRA CHARGE

- » straight edge and edge without rebate in CPL laminate is coated with edgeband 1,5 mm thick
- » glass pane MAT DRE, DECORMAT BROWN, DECORMAT GRAPHITE (applies to door leaf) PLUS 20 PLUS 40, 50, 60, 70, 80 PLUS 30
- » white frost VSG 22.1 safe, complex glass pane p. 81
- » core made of: perforated chipboard (1983 and 2043) core made of perforated chipboard (2110 and 2240)
- » door leaf „90” and „100” (1983 and 2043)
- » door leaf "90" and "100" (2110 and 2240)
- » non-rebated door leaf
- » ventilation undercut
- » plastic ventilation grille
- » aluminum ventilation grille
- » cover-up strip for double leaf non-rebated door
- » double leaf door leaf price x2
- » NOTE: third hinge Estetic 80 for non-rebated doors (additional payment is added to the price of the door frame)

NEW

NOTE: collection PLUS 10-80 coated with CPL laminate in standard height is available in sliding version.

fig. 1

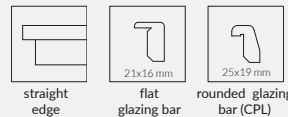
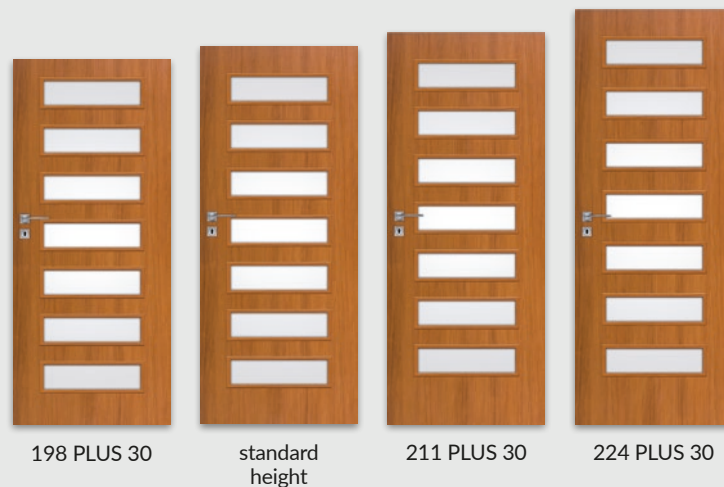
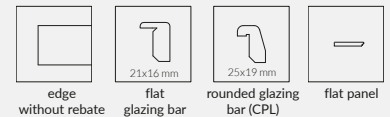

fig. 2



white (structure)	ash	beech	alder	golden oak	calvados	walnut	Decor DRE-Cell 1						gray textured	black textured	toffee oak ...	Decor DRE-Cell 2
white mat	white pine	siberian elm	silver	sand oak	bleached oak textured	vintage oak	caramel walnut	golden oak textured	dark walnut textured	gray oak textured**	tabac elm	anthracite elm	dark wenge	Decor DRE-Cell 2		
white	noble white VVF7206	light gray	dark gray	concrete 1 F6462	concrete 2	gray oak	welsh oak	acacia	celini walnut	walnut	honey oak	chestnut	roasted walnut	CPL Laminate		

*** decor available only in horizontal wood grain



ENA - white mat

DRE sliding system is designed to be used together in one set with single or double leaf door, which are available in our sale offer in sliding version. Sliding system is available in veneer colours which constitute standard finishing colours of door leaf unit: DRE - Cell, 3D foil, CPL laminates, natural veneers, and painted doors with the exception of the following collections: Enter, Enter Natura, Solid, Solid RC2, Vetro C, Lack, Ascada, Sinco, Duo, Rim, fire resistance doors, glass doors, and doors with different heights.

In our sale offer there are available two different types of sliding system:

NS - system mounted directly on the wall

NT - sliding system mounted together with adjustable tunnel

There are two options of NT sliding system:

mounted together with adjustable tunnel with 63 mm architrave

mounted together with adjustable tunnel with 80 mm architrave

Set of sliding system comprises of: sliding guide bar with hardware (LEON SN 150, 180, 200), spacing board, masking strip, and fender beam (fender beam is available for single leaf - for doors with hook lock option in fender beam there is milling for latch).

In the system mounted with adjustable tunnel NT set contains 2 additional 16 mm spacing boards with cross-sections adapted to the width of architraves (63 mm or 80 mm). There are differences in cross-sections of NS and NT masking element.

To complete entire set of sliding doors it is necessary to purchase sliding leaf unit in following dimensions:

Single leaf door: „60“, „70“, „80“, „90“, „100“

Double leaf door: „2x60“, „2x70“, „2x80“, „2x90“, „2x100“

Door leaf might be equipped with sockets for lock and/or handle - those accessories must be purchased separately.

In the system mounted with adjustable tunnel NT, it is necessary to purchase adjustable tunnel separately.

SLIDING SYSTEM

WALL MOUNTED SLIDING SYSTEM

ACCESSORIES



- » round handle 1 pcs.
 - » oval handle 1 pcs.
 - » Hook lock with with two round or oval handles with the key
 - » hook lock with toilet option with two round or oval handles PLN
 - hook lock with cylinder with two round handles
- One set of door handle for single door leaf consist of 2 pcs.

masking strip with guide bar

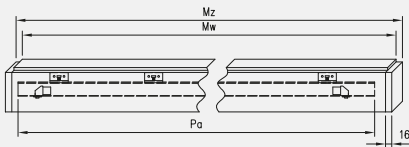

Masking strip and guide bar for double sliding system is made by connecting two elements of single system.



Single sliding system

Dimension door [mm]	Masking strip		Guide bar
	Mz	Mw	Pa
644, 744	1620	1588	1500
844	1920	1888	1800
944	2120	2088	2000
1044	2140	2108	2000

double leaf sliding system

Dimension door [mm]	Masking strip		Guide bar
	Mz	Mw	Pa
2 x 644	2 x 1519	2 x 1503	2 x 1500
2 x 744	2 x 1519	2 x 1503	2 x 1500
2 x 844	2 x 1819	2 x 1803	2 x 1800
2 x 944	2 x 2019	2 x 2003	2 x 2000
2 x 1044	2 x 2063	2 x 2047	2 x 2000

NS - vertical cross-section

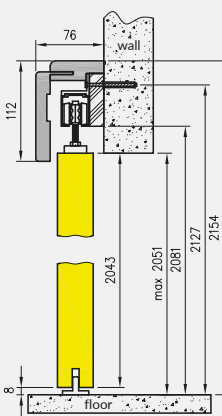

NT - vertical cross-section for tunnel with 63 mm architrave

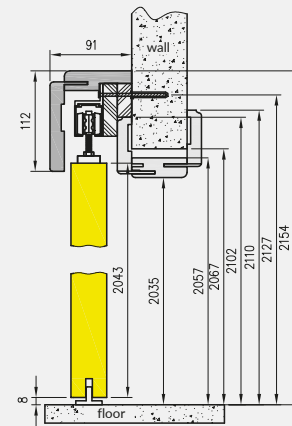

NT - vertical cross-section for tunnel with 80 mm architrave

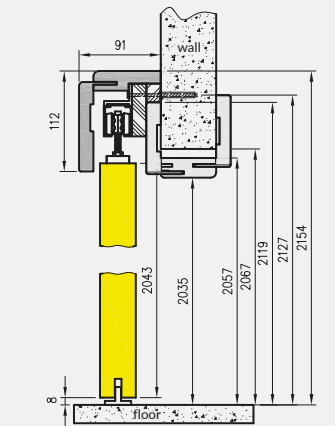

Height of sliding door leaf unit - 2043 mm
total height of sliding system - 2154 mm

Single sliding system

symbol	„60”	„70”	„80”	„90”	„100”
A	600	700	800	900	1000
C	644	744	844	944	1044
D	664	764	864	964	1064
E	750	850	950	1050	1150
E*	784	884	984	1084	1184
S	644	744	844	944	1044

double leaf sliding system

symbol	„120”	„140”	„160”	„180”	„200”
A	1200	1400	1600	1800	2000
C	1244	1444	1644	1844	2044
D	1264	1464	1664	1864	2064
E	1350	1550	1750	1950	2150
E*	1384	1584	1784	1984	2184
S**	644	744	844	944	1044

NS - horizontal cross-section (left system)

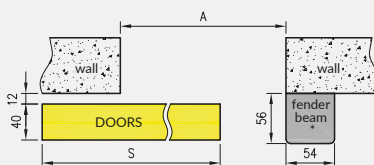

NT - horizontal cross-section (left system)

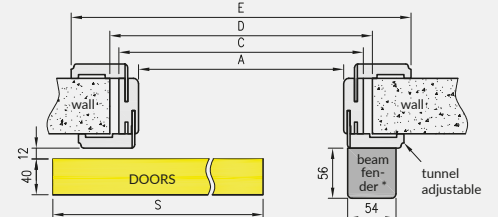

* is not available in double leaf system

E* applies to tunnel with T80 architrave
S** width of single door leaf

NOTE: In double sliding system masking strip is connected in point, of two single elements.



GOSSA 4 - glass doors sliding system

Sliding system for glass doors "Spazio", is made of anodized aluminum, and used as a complete and complementary solution together with finished door frame. Whole set comprises of - guide channel with straight or oval blende, hardware designed to hang sliding glass pane and bottom door guide.

There are two options of Spazio System (only difference is in the shape of external blende):

- » Spazio TP - with straight blende
- » Spazio TO - with oval blende

PRICE

- » price of sliding system for a glass doors

To complete the whole system it is recommended to buy glass door leaf in sliding version from one of our collections: Galla, Gracca or Gossa. There is designed for this solution round handle.

OPTIONS AVAILABLE WITH EXTRA CHARGE

- » door handle (two-sided)



door handle
(stainless steel)

Note: There is no possibility to make ventilation option.

sliding glass door leaf

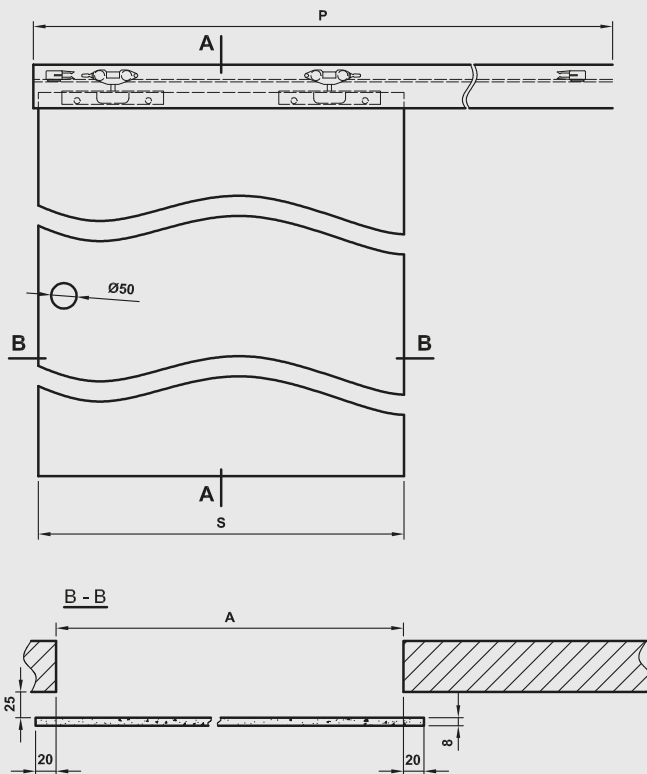
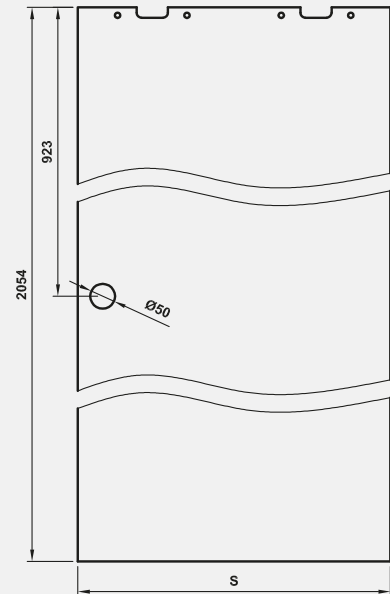

A - A vertical cross-section of Spazio TP

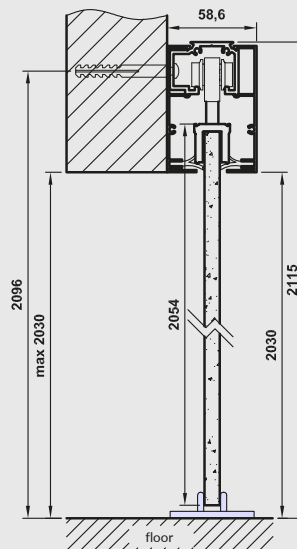

A - A vertical cross-section of Spazio TO

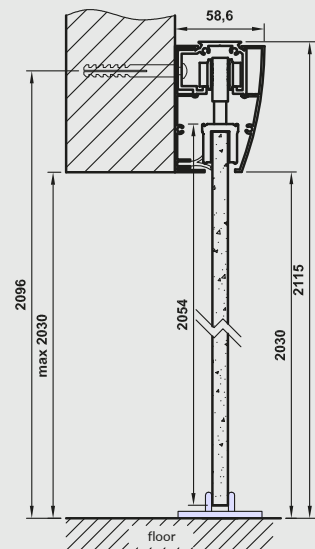

Dimensions

	S	A	P
„60”	630	590	1340
„70”	730	690	1540
„80”	830	790	1740
„90”	930	890	1940

S - width of door leaf unit
A - width of wall passage
P - length of guide channel



Sliding system SPAZIO CD - STANDARD 10 sand oak

SLIDING SYSTEM SPAZIO CD MOUNTED ON-WALL

SLIDING SYSTEM DOOR LEAVES
interior door leaves

SPAZIO CD

Mounted on-wall sliding system with anodized guide channel and rectangular blende, is designated for panel doors and frame construction doors.

WHOLE SET COMPRISES OF:

- » guide channel with side caps
- » system sliding trolleys
- » door leaf hangers
- » bottom stopper
- » assembly kit (screws and bolts)

To complete the whole system it is recommended to buy door leaf in sliding system version available in our standard sale offer together with door handle. Door handle is to be purchased separately (informations pp. 115).

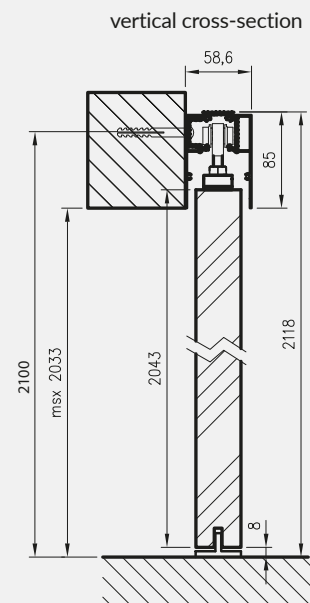
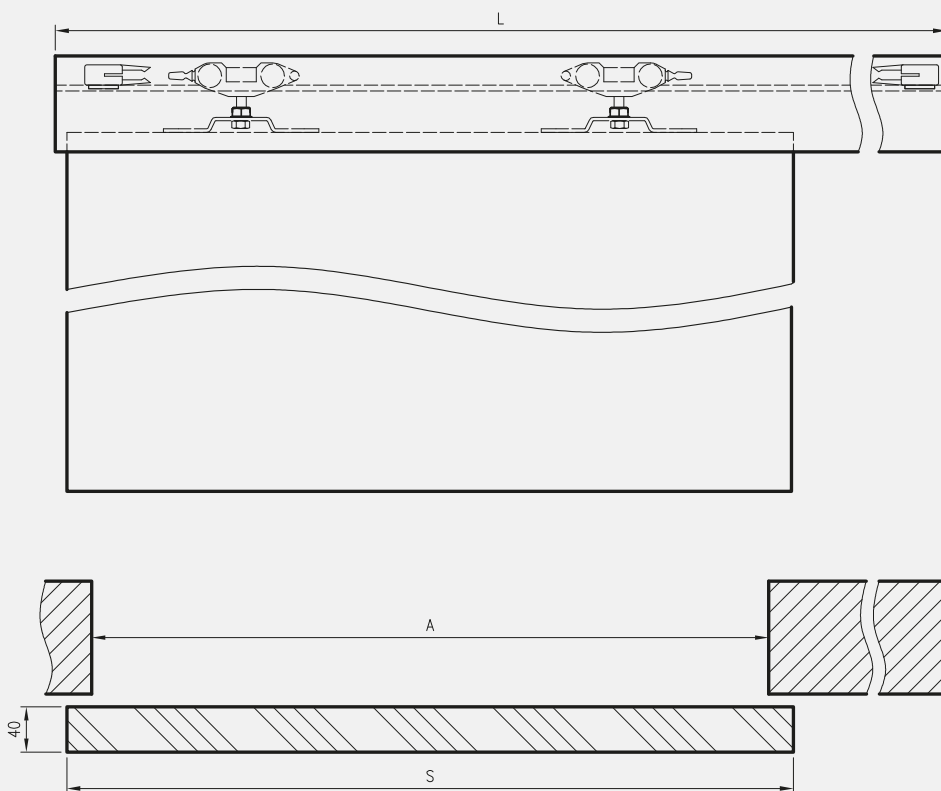

	A	S	L
„60”	600	644	1370
„70”	700	744	1570
„80”	800	844	1770
„90”	900	944	1970
„100”	1000	1044	2170

A - width of wall passage
S - width of door leaf unit
L - length of guide channel



Sliding system doors hidden in the wall (pocket system) PA - STANDARD 10 vintage oak

Decor DRE-Cell	white (structure)	white mat	white pine	siberian elm	silver	ash	beech	vintage oak	sand oak	bleached oak textured	alder	golden oak
	calvados	walnut	caramel walnut	golden oak textured	dark walnut textured	gray oak textured***	tabac elm	anthracite elm	dark wenge	gray textured	black textured	toffee oak ***
Decor 3D	grand oak	elm	american walnut	ebony	polish oak 3D							

*** Decor available only in horizontal wood grain

SLIDING SYSTEM DOORS HIDDEN IN THE WALL (POCKET SYSTEM)

SLIDING SYSTEM DOOR LEAVES

interior door leaves

SLIDING SYSTEM DOORS HIDDEN IN THE WALL (POCKET SYSTEM) PA - 125 MM

Sliding system doors hidden in the wall (pocket system) PA - it is sliding system doors, hidden in the wall designated for wall construction made of light gypsum cardboard.

TECHNICAL PARAMETERS:

Assembly of sliding system doors hidden in the wall should be done by using construction of the profiles used to build gypsum cardboard walls with total thickness 125 mm (or optional construction with total thickness 125 mm). After assembly, it is necessary to finish wide surfaces with plasterboards 12,5 mm thick (plasterboards shall be purchased separately), continue with detailing process of those surfaces and assemble tunnel cover of sliding system.

SET COMPRISES OF:

- » cassette elements made of aluminum elements and additional assembly accessories
- » elements which allows to decorate build in sliding system - so called tunnel cassette cover with architraves 80 mm wide

To complete whole system it is necessary to purchase: door leaves available in sliding system (it is recommended to purchase door leaf with "thimble" option) hardware for this door leaf (lock and/or door handle and thimble).

NOTE: VETRO A, VETRO D and VETRO B door leaf with width "70" is not complementary product for sliding system doors hidden in the wall (pocket system) PA.

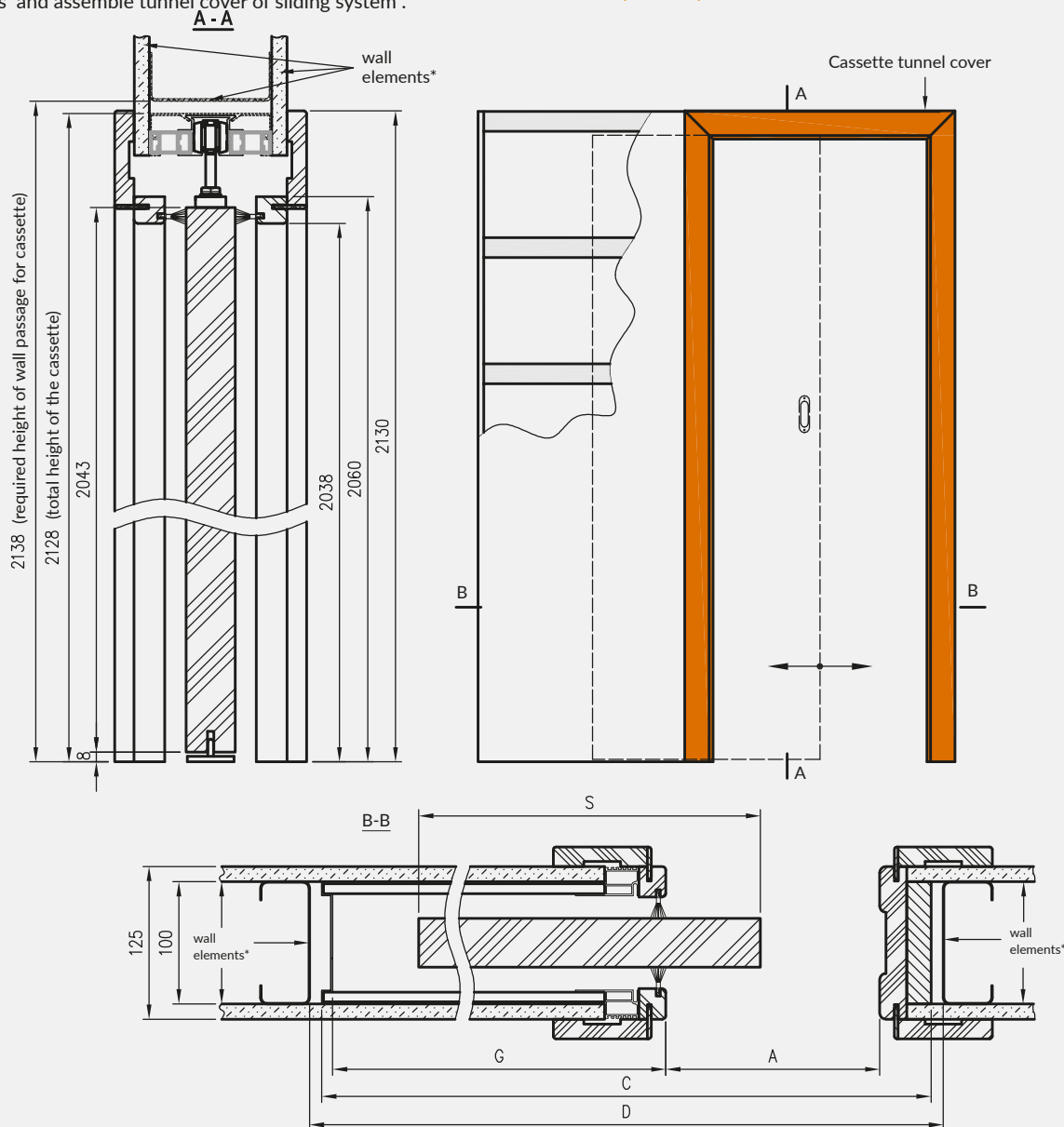

	A	S	C	D	G
60	600	644	1310	1330	659
70	700	744	1510	1530	759
80	800	844	1710	1730	859
90	900	944	1910	1930	959
100	1000	1044	2110	2130	1059

C - total width of cassette
 D - width of walls passage prepared for cassette
 G - depth of finished cassette



folding doors FOLDE 10 - white matt

Decor DRE-Cell 1	white (structure)	ash	beech	alder	golden oak	calvados	walnut								
Decor DRE-Cell 2	white mat	white pine	siberian elm	silver	sand oak	bleached oak textured	vintage oak	caramel walnut	golden oak textured	dark walnut textured	gray oak textured**	tabac elm	elm anthracite	dark wenge	
	gray textured	black textured	toffee oak ***												
Decor 3D	grand oak	elm	american walnut	ebony	polish oak 3D										

*** Decor available only in horizontal wood grain

System of folding doors is characterised by that, during opening process of door leaf unit, doors fold into parallel position . The complete set of folding doors comprises of:

- » two-element door leaf, interconnected by 3 hidden concealed hinges
- » adjustable door frame for folding doors

STANDARD OPTIONS

- » door leaf frame made of softwood
- » core made of „honeycomb”
- » straight edge **fig. 1**
- » single-point mortise lock for simple key, for bathroom lock, for cylinder lock or economic lock
- » 3 hidden concealed ISTAR hinges instaled between two-element door leaf unit

fig. 1



OPTIONS AVAILABLE WITH EXTRA CHARGE

- » core made of perforated chipboard
- » door leaf „90” and „100”

Cross-section of folding doors in closed position*
(right doors, left doors it is mirror reflection)

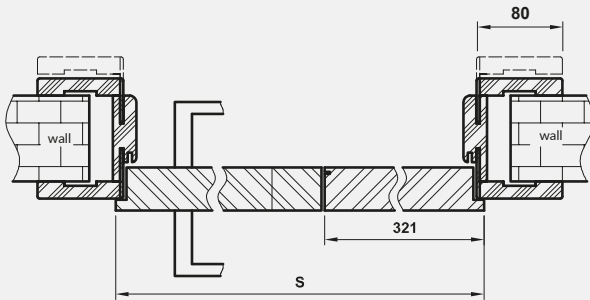

Cross-section of folding doors in opened position*

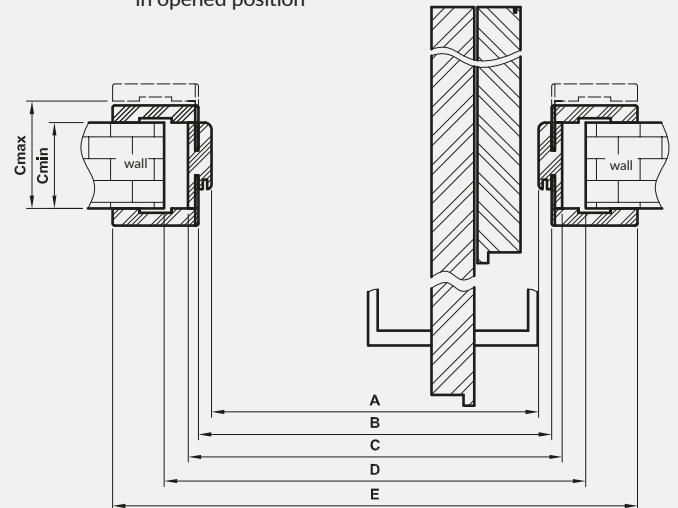

Dimensions

	S	A	B	C	D	E
„80”	844	806	830	850	880	990
„90”	944	906	930	950	980	1090
„100”	1044	1006	1030	1050	1080	1190

D - required width of wall passage

NOTE: There is no possibility to shorten door leaf.

*NOTE: When doors are fully opened, door fittings slightly reduce clear opening by approx. 10 cm. (this value doesnt take into account door handle)

vertical cross-section

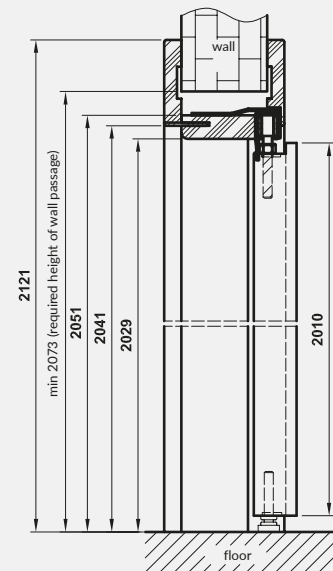



Sara Eco

Decor DRE-Cell	white (structure)	white mat	white pine	siberian elm	silver	sand oak	bleached oak textured	vintage oak	ash	beech	alder	golden oak	calvados
	caramel walnut	golden oak textured	walnut	dark walnut textured	gray oak textured***	tabac elm	anthracite elm	dark wenge	gray textured	black textured	toffee oak ***		
Decor 3D	grand oak	elm	american walnut	ebony	polish oak 3D								
Decor	primed												
Decor painted	white	ecru	latte	ashen									

*** Decor available only in horizontal wood grain

Available colours of aluminum door frames



anode

White
RAL 9003

aluminum

white acrylic UV varnish - RAL 9003
 ecru - RAL 9001
 latte - Flugger 4362, NCS S1505-Y50R
 ashen - RAL 7035

NON-REBATED DOOR LEAF - OPENED OUTWARDS

Sara Eco door leaf is an innovative solution for creative interior design with the use of "invisible" doors. This unique construction gives possibility to finish surface of door leaf in the colours of walls.

CONSTRUCTION OF SARA ECO DOOR LEAF COMPRISES OF:

Aluminum door frame, "invisible" after assembly process, build in the wall or overlaid with sheets of plaster board. After detailing process, only one visible part is rebate of the door frame, prepared for future painting, e.q. in the colours of the walls.

Non- rebated panel construction door leaf is available in two finishing options:

- » wide surfaces of door leaf are primed and ready for painting or paperhanging (e.q. in the colour of the walls). Edges of the leaf are covered with a paintable edge band. Painting is to be done at one-s discretion or there is possibility to choose painted decor.
- » wide surfaces of door leaf are coated with veneer from DRE - Cell or 3D group, while the edges of the leaf are covered with a edge band in the colour of the veneer.

OPTIONS AVAILABLE WITH EXTRA CHARGE WITH PRIMER

- » ventilation undercut

STANDARD OPTION

- » door leaf frame made of softwood
- » sockets for 2 hidden concealed ISTAR hinges
- » core made of „honeycomb”
- » magnetic lock for simple key, for bathroom lock, for cylinder lock or economic lock

OPTIONS AVAILABLE WITH EXTRA CHARGE IN DRE-CELL, 3D AND PAINTED

- » ventilation undercut
- » plastic ventilation grille
- » aluminum ventilation grille
- » dropping seal

price of door frame includes two hidden concealed hinges.

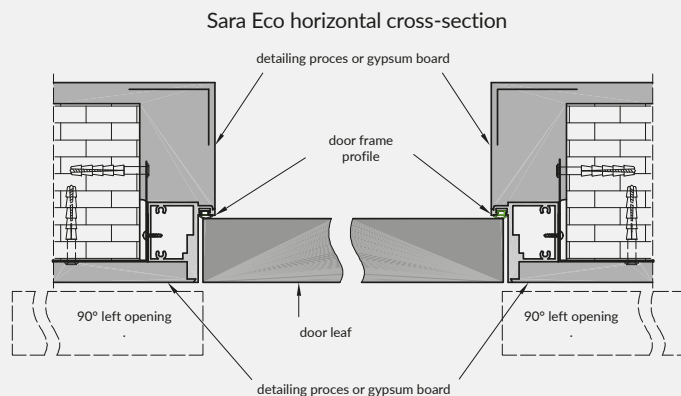

Sara Eco horizontal cross-section (assembly in Gypsum wall)

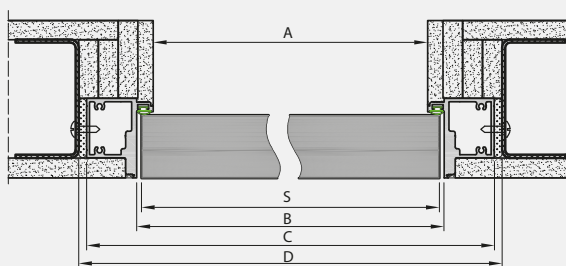

Sara Eco vertical cross-section

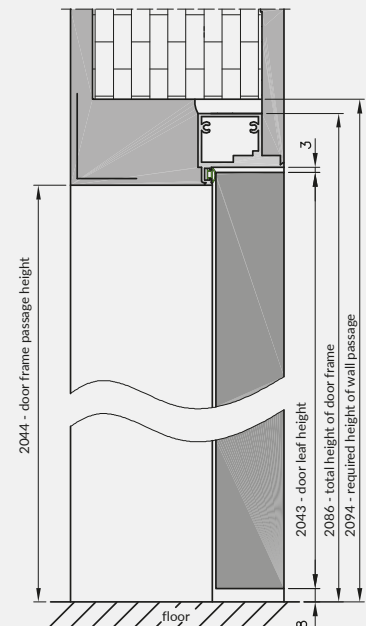

door frame profile with gasket

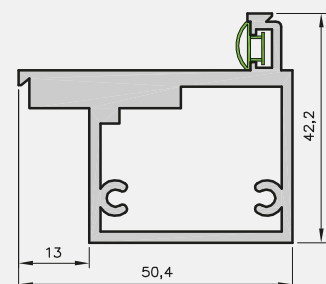

Dimensions of Sara Eco door leaf

	S	A	B	C	D
„60”	644	629	650	714	724
„70”	744	729	750	814	824
„80”	844	829	850	914	924
„90”	944	929	950	1014	1024
„100”	1044	1029	1050	1114	1124

- S - width of door leaf unit
- A - width of passage in door frame unit
- B - width in rebate of door frame
- C - external width of door frame
- D - required width of wall passage

NOTE: Minimum thickness of the wall 75 mm.

Door leaf width: single leaf door „60”÷„100” .

REBATED DOOR LEAF - OPENED INWARDS

Sara Eco door leaf is an innovative solution for creative interior design with the use of "invisible" doors. This unique construction gives possibility to finish surface of door leaf in the colours of walls.

Construction of SARA ECO door leaf comprises of:

- » Aluminum door frame, "invisible" after assembly process, built in the wall or overlayed with sheets of plaster board. After detailing process, only visible part is rebate of the door frame, prepared for future painting, e.q. in the colours of the walls.
- » Rebated panel construction door leaf is available in two finishing options:
 - » wide surfaces of door leaf are primed and ready for painting or paperhanging (e.q. in the colour of the walls). Edges of the leaf are covered with a paintable edge band. Painting is to be done at one's discretion or there is possibility to choose painted decor.
 - » wide surfaces of door leaf are coated with veneer from DRE - Cell or 3D group, while the edges of the leaf are covered with a edge band in the colour of the veneer.

OPTIONS AVAILABLE WITH EXTRA CHARGE WITH PRIMER

- » ventilation undercut

STANDARD OPTION

- » door leaf frame made of softwood
- » sockets for 2 hidden concealed ISTAR hinges
- » core made of „honeycomb”
- » magnetic lock for simple key, for bathroom lock, for cylinder lock or economic lock

OPTIONS AVAILABLE WITH EXTRA CHARGE IN DRE-CELL, 3D AND PAINTED

- » ventilation undercut
- » plastic ventilation grille
- » aluminum ventilation grille
- » dropping seal

Sara Eco horizontal cross-section

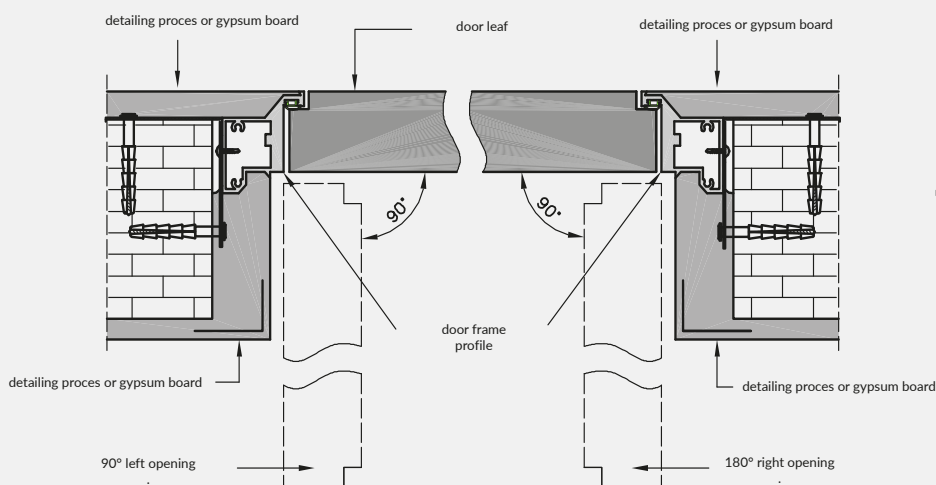

Sara Eco horizontal cross-section (assembly in Gypsum wall)

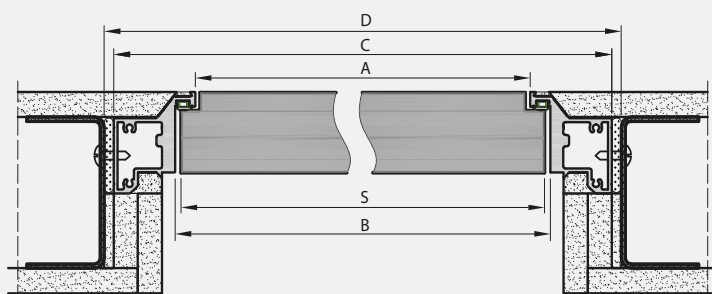

Dimensions of Sara Eco door leaf

	S	A	B	C	D
„60”	644	629	650	714	724
„70”	744	729	750	814	824
„80”	844	829	850	914	924
„90”	944	929	950	1014	1024
„100”	1044	1029	1050	1114	1124

S - width of door leaf unit
 A - width of passage in door frame unit
 B - width in rebate of door frame
 C - external width of door frame
 D - required width of wall passage

NOTE: Minimum thickness of the wall 75 mm.
 Door leaf width: single leaf door „60”÷„100”.

Sara Eco vertical cross-section

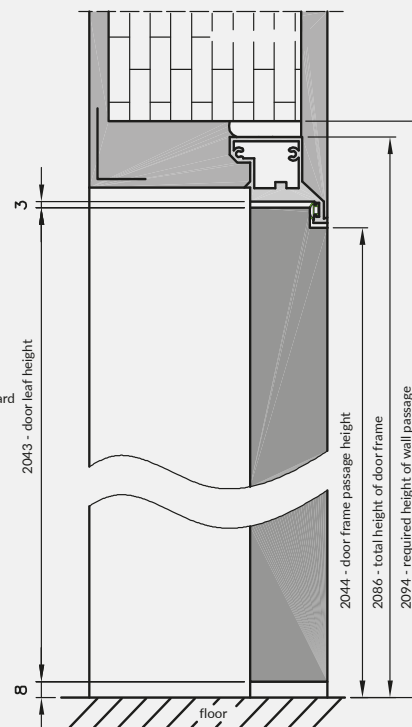

door frame profile with gasket

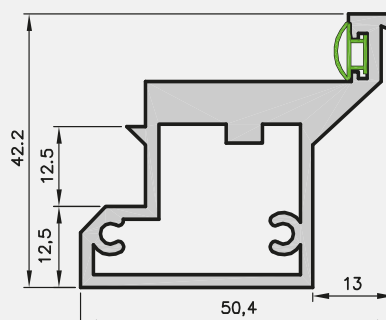

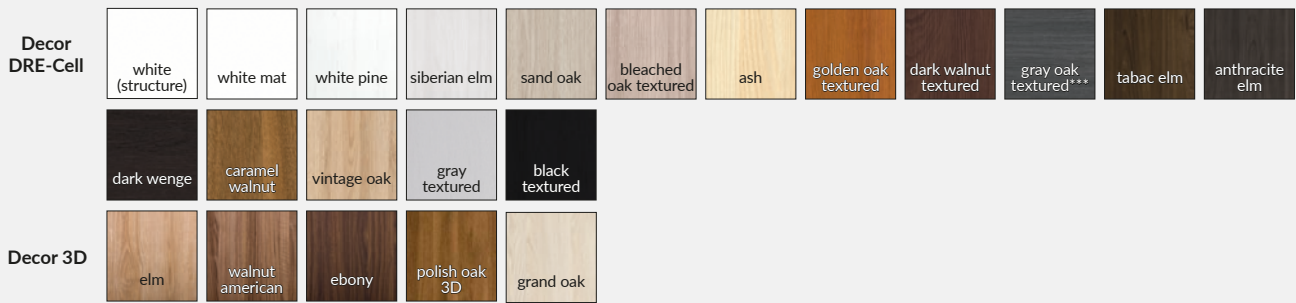

*** Decor available only in horizontal wood grain



side panel PREMIUM natura (straight edge) Natura
 side panel DOVA natura (straight edge) Natura
 side panel SCALA natura (straight edge) Natura

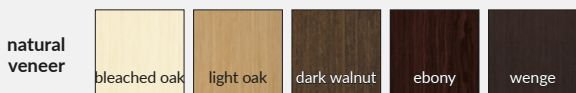

STANDARD OPTIONS

- » stiles and rails made of MDF
- » glass pane 4 mm: MAT DRE, decormat brown, decormat graphite or transparent glass
- » 3 silver screw-in pivot hinges
- » latch strike plate and two flush bolts
- » straight edge **fig. 1**

OPTIONS AVAILABLE WITH EXTRA CHARGE

- » door frame for door leaf with side panel +30%

NOTE: Price of side panel is equal to the price of corresponding door leaf model.

There is possibility to make side panels to all frame construction door leaf, available in presented collections, in following options: „60+40“; „70+40“; „80+40“; „90+40“; „100+40“

NOTE: There is no possibility to shorten side panels.

fig. 1



STANDARD OPTIONS

- » door leaf frame made of softwood
- » core made of „honeycomb“
- » glass pane 4 mm thick: white bark, "window blind", CHINCHILA, MAT DRE, DECORMAT BROWN or DECORMAT GRAPHITE.
- » 2 silver screw-in pivot hinges
- » latch strike plate and two flush bolts
- » optional: straight edge* flat glazing bar **fig.1** or "karnies" edge, rounded glazing bar **fig. 2**

OPTION WITHOUT ADDITIONAL CHARGE

- » three hinges applies to rebated door leaf

OPTIONS AVAILABLE WITH EXTRA CHARGE

- NEW** » white frost VSG 22.1 safe, complex glass pane
SIDE PANEL 30
SIDE PANEL 40
SIDE PANEL 41
- » core made of perforated chipboard
- » door frame for door leaf with side panel +30%
- » straight edge in CPL laminate with edge band 1,5 mm thick

Side panel it is, 40 mm thick, passive rebated door leaf unit "40" width, with glazing or without glazing option, in uniform wood grain. Side panels can be paired with interior rebated door leaf in the following combination: „60+40“; „70+40“; „80+40“; „90+40“; „100+40“.

Side panel 10 can be applied to rebated interior door leaf. Side panel 30 can be applied to models ARTE 10-30 and STANDARD 30. Side panel 40 can be applied to models ARTE 40, 50, 90; STANDARD 40, KANON 30, DECO collection. Side panel 41 can be applied to models MODERN 30, IDEA 30, PLUS 30.

To make the best possible match of side panel, to the door leaf unit, besides selection of model, it is necessary to choose right colour, type of the edge and number of hinges.

NOTE: There is no possibility to shorten side panels.

fig. 1

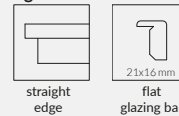
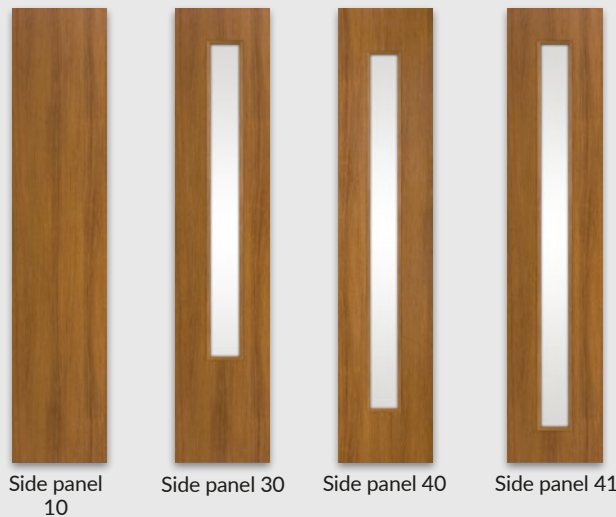
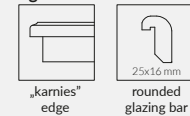

fig. 2



Decor DRE-Cell 1	white (structure)	ash	beech	alder	golden oak	calvados	walnut	Decor 3D	elm	walnut american	ebony	polish oak 3D	grand oak	
	white mat*	white pine	siberian elm	silver	sand oak	bleached oak textured	vintage oak		caramel walnut	golden oak textured	dark walnut textured	gray oak textured***	tabac elm	anthracite elm
Decor DRE Cell 2	gray textured	black textured	toffee oak ***											
CPL Lami- nate	white	noble white VVF7206	light gray	gray dark	concrete 1 F6462	concrete 2	gray oak	welsh oak	acacia	celini walnut	walnut	honey oak	chestnut	roasted walnut

* decor is not available in door leaf model with "karnies" edge

** available only straight edge

*** decor available only in horizontal wood grain

STANDARD OPTIONS

- » door leaf frame made of softwood
- » core made of „honeycomb”
- » glass pane 4 mm thick: white bark, "window blind", CHINCHILA, MAT DRE, DECORMAT BROWN or DECORMAT GRAPHITE.
- » 2 silver screw-in pivot hinges
- » latch strike plate and two flush bolts
- » straight edge **fig. 1**

fig. 1

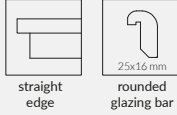

OPTION WITHOUT ADDITIONAL CHARGE

- » three hinges

OPTIONS AVAILABLE WITH EXTRA CHARGE

- » white frost VSG 22.1 safe, complex glass pane NEW
- SIDE PANEL 30
- SIDE PANEL 40
- » core made of perforated chipboard
- » door frame for door leaf with side panel +30%

Interior rebated single leaf door can be paired together with "40" side panel in the following options „60+40"; „70+40"; „80+40"; „90+40"; „100+40". Side panel it is passive rebated door leaf unit 40 mm thick, with glazing or without glazing option, in uniform wood grain.

Side panel Natura 10 can be applied to all collections with natural veneer and with straight edge, besides ENTER natura..

Side panel Natura 02 can be applied to collection Galeria Natura 02, 20, 21, 22, 23, Galeria Natura ALU 20,21,22,23, 24, 25 and Duero Natura ALU.

Side panel Natura 30 can be applied to models ARTE natura 10-30, STANDARD natura 30 with straight edge.

Side panel Natura 40 can be applied to models ARTE natura 40, 50, 70, 90, STANDARD natura 40.

NOTE: There is no possibility to shorten side panels.



Side panel Natura 10 (horizontal wood grain, straight edge) Side panel Natura 02 (horizontal wood grain, straight edge) Side panel Natura 30 (horizontal wood grain, straight edge) Side panel Natura 40 (horizontal wood grain, straight edge)



TRANSOM LIGHTS AND SIDE LIGHTS



Possible configuration of transom lights/side lights



TRANSOM LIGHTS AND SIDELIGHTS

Transom lights/ sidelights are fixed, unpenable, glazed partition between rooms or spaces that may constitute an independent unit or a supplement for interior doors (except for glass doors) with a fixed door frames. Transom lights/sidelights are manufactured and delivered as a set of components ready for assembly. Set contains the following:

- » two horizontal and two vertical main beams
- » set of cover and instalation strips
- » set of gaskets
- » main beam couplers

Transom lights/sidelights are used in interior doors with a fixed door frames and they come in the following decors DRE-Cell, 3D , Finish, CPL laminate 0,15-0,20 mm and painted.

NOTE: Our product doesnt come with the glass pane, it should be purchased by the Client separately. We reccomend to use tempered glass pane with a thickness of 4 mm. Assembly of transom lights/sidelights should be performed once the "wet" construction are completed.

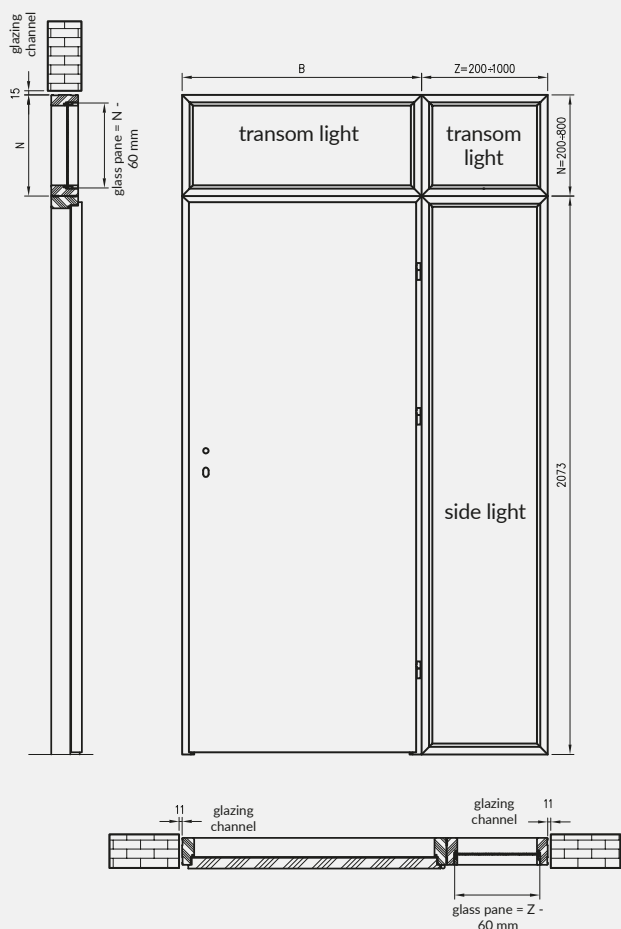
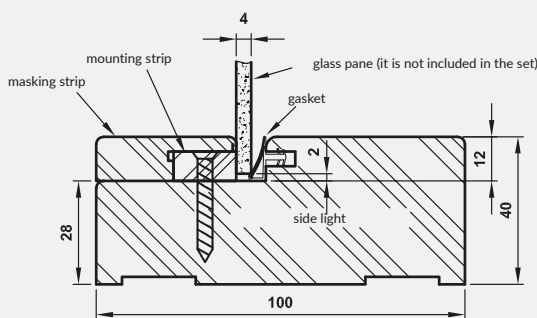

Fig. A cross-section of the transom light/sidelights



Dimensions of transom lights/sidelights

range of products	total height	total width	length of the perimeter
sidelight	2073 mm	Z	$2 \cdot 2073 + 2 \cdot Z$
sidelight	N	Z	$2 \cdot N + 2 \cdot Z$
transom light	N	B	$2 \cdot N + 2 \cdot B$

available heights options of transom lights

„N” = 200-800 mm.

available options of the width of transom and sidelights

„Z” = 200-1000 mm.

Width of the upper "B" transom lights is adjusted to the width of the fixed door frames; the available options of the width of fixed door frames; available options of the widths can be found in the following tables:

The transom lights are mounted on the single-leaf door frame

	„60”	„70”	„80”	„90”	„100”	„110”
B	688	788	888	988	1088	1188

Transoms mounted with the door frame in double-leaf doors

	„100d”	„110d”	„120”	„130”	„140”	„150”	„160”	„170”	„180”	„190”	„200”
B	1123	1223	1323	1423	1523	1623	1723	1823	1923	2023	2123

Price of the transom lights/sidelights is calculated per one meter of circumference measured on the outer side of the transom lights/sidelights.

Price of the transom lights/sidelights is calculated per one meter of circumference measured on the outer side of the transom lights/sidelights. In order to . To place an order please contact Atypical Orders Department - phn. 55 236 42 59.

NOTE: height of the sidelight is adapted to the standard height of the fixed door frame. Therefore, we do not reccomend shortening door frames in configuration with the sidelight.

ENTER NATURA

REBATED
interior entrance door leaf



STANDARD OPTIONS

- » door leaf frame made of MDF additionally reinforced with two flat metal bars
- » core made of perforated chipboard
- » external flat HDF board
- » 3 silver screw-in pivot hinges
- » straight edge **fig. 1**
- » bottom deadbolt lock adapted for door lock cylinder
- » upper deadbolt lock adapted for door lock cylinder

fig. 1

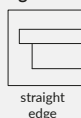

APPLICATION

Door leaf ENTER natura can be used as internal entrance door in multifamily buildings and public utility buildings.

NOTE: The specificity of natural veneer is a possibility of differences in wood grain and staining. These differences can not be the basis of the accepted complaint..

OPTIONS AVAILABLE WITH EXTRA CHARGE

- » viewfinder - included separately
- » digital viewfinder DDS1 - separately
- » digital viewfinder DDS2 - separately
- » stainless steel threshold - 70 mm wide
- » cancellation of second lock
- » dropping seal

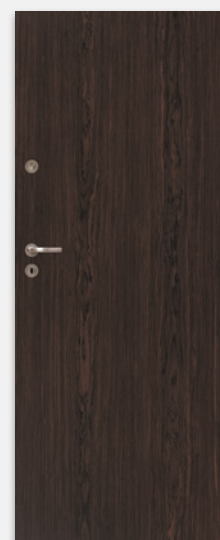

ENTER natura 0



viewfinder included separately

steel threshold (70 mm wide)

upper deadbolt lock

dropping seal

digital viewfinder (separately)

DDS1

digital viewfinder DDS2 (separately)

CONSTRUCTION

Construction door leaf frame is made of MDF board (A) additionally reinforced with two flat metal bars (B).

Core is made of perforated chipboard (C).

Door leaf unit has increased acoustic insulation (Rw=32dB). External HDF board is ennobled with natural veneer secured with UV varnish.

It is recommended to use together with door leaf collection ENTER natura fixed door frame Soft natura.

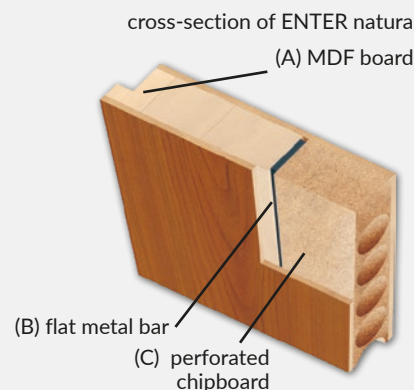

PATENTED CYLINDERS



patented cylinder 26/41
- nickel mat



patented cylinder 26/41
- brass satin



set of patented cylinder ZN
30/40+30G/40 SN
or ZN 30/40+40G/30 SN nickel satin

single key system

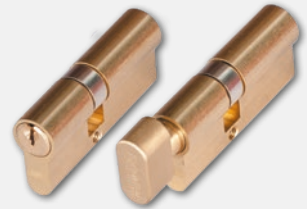

set of patented cylinder ZN
30/40+30G/40 SB
or ZN 30/40+40G/30 SB brass satin

DIGITAL VIEWFINDER AXA DDS1



DIGITAL VIEWFINDER AXA DDS2

SELF-CLOSER



self-closer DORMA



self-closer GEZE



DIVA door handle and back plate
for FORCA 10 and FORCA B 10
silver colour F1



ONTARIO door handle
and backplate
for SOLID RC2 model
titanium colour

ENTER/SOLID

REBATED DOOR LEAVES
interior entrance



STANDARD OPTIONS

- » door leaf frame made of MDF additionally reinforced with two flat metal bars
- » core made of perforated chipboard
- » external HDF board - flat or with decorative milling .
- » 3 silver screw-in pivot hinges
- » straight edge **ig. 1** or edge R 2,5 mm (in CPL laminate) **ig. 2**

REBATED DOOR LEAF MODEL ENTER:

- » bottom deadbolt lock adapted for door lock cylinder
- » upper deadbolt lock adapted for door lock cylinder
- » **Orders, in investment standard, will be executed after consultations with Untypical Orders Department. By investment standard, is defined door frame passage, with opened door leaf at 90 degree, interior entrance doors "80" 800 mm, "90" 900 mm.**

REBATED DOOR LEAF SOLID

- » multipoint mortise lock
- » hinges reinforced with anti-thrust bolts
- » **Orders, in investment standard, will be executed after consultations with Untypical Orders Department. By investment standard, is defined door frame passage, with opened door leaf at 90 degree, interior entrance doors "80" 800 mm, "90" 900 mm.**

APPLICATION

Door leaf ENTER and SOLID can be used as interior entrance door in multifamily and in public utility buildings.

CONSTRUCTION

Construction door leaf frame is made of MDF, additionally reinforced with two flat metal bars. Core is made of perforated chipboard. Door leaf unit has increased acoustic insulation (Rw=32dB). External HDF board is ennobled with DRE-Cell veneer - optional - flat finishing or decorative milling.

Door leaf models ENTER/SOLID are available with 0,7-08 mm CPL laminate - to place an order and for more information please contact Customer Service Department.

NOTE: Models ENTER 0 and SOLID 0 - door leaf in CPL laminate has in standard option edge with radius R 2,5 mm. There is possibility to choose straight edge (extra charge) with edge band 1,5 mm thick.

It is recommended to use together with door leaf collection ENTER/SOLID fixed door frame ENTER/SOLID or metal door frame.

fig. 1



straight edge

fig. 2

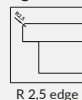

R 2.5 edge

* door handle and upper backplate METRO, set of patented cylinder - single key system

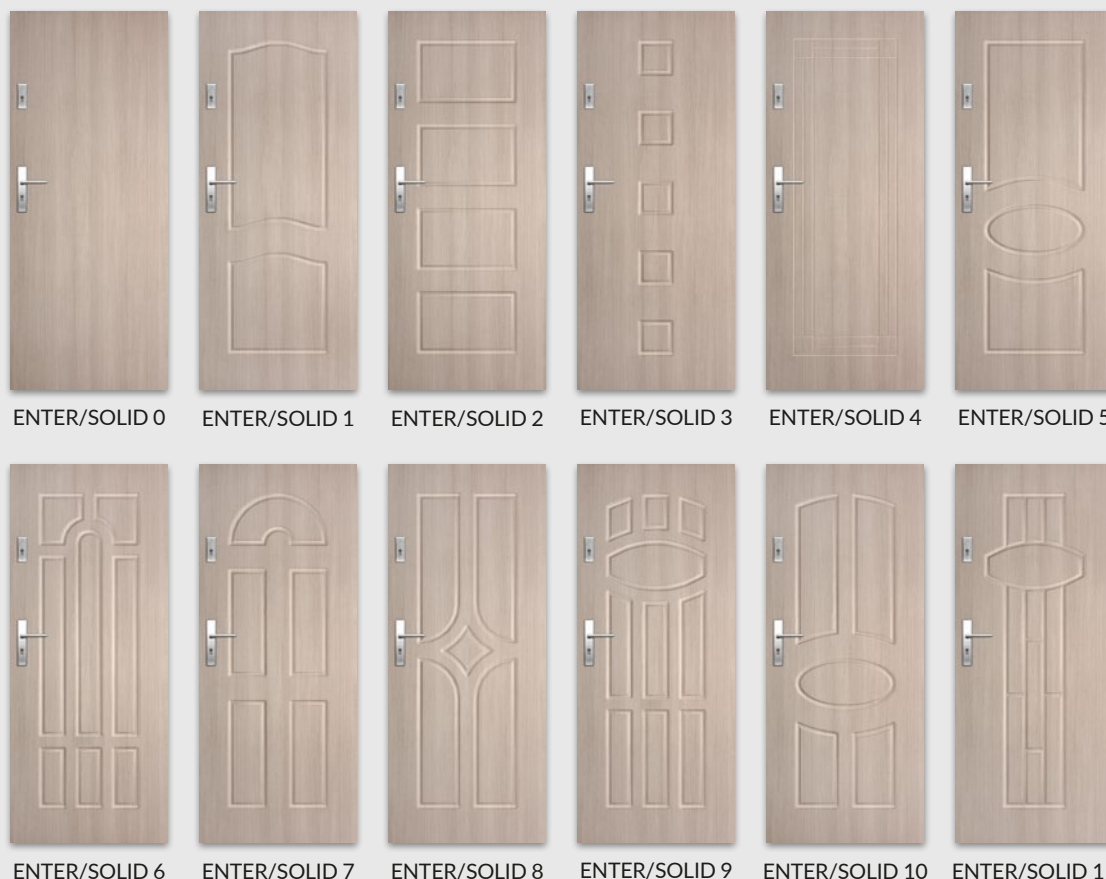

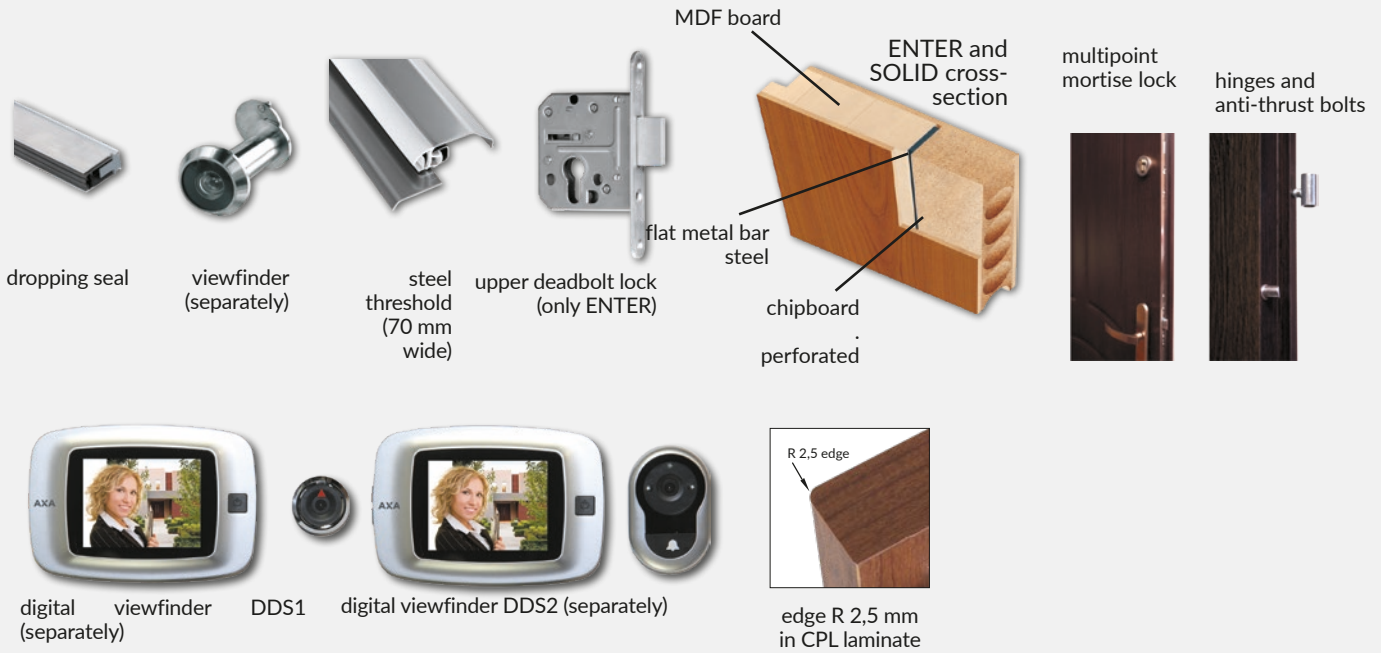

OPTIONS AVAILABLE WITH EXTRA CHARGE

- » In CPL laminates straight edge with edge band 1,5 mm thick
- » viewfinder - included separately
- » digital viewfinder DDS1 - separately
- » digital viewfinder DDS2 - separately
- » stainless steel threshold - 70 mm wide
- » cancellation of second lock
- » dropping seal

Decor DRE-Cell 1	white (structure)	ash	beech	alder	golden oak	calvados	walnut	Decor DRE-Cell 2					white mat	silver
	white pine	siberian elm	sand oak	bleached oak textured	vintage oak	caramel walnut	golden oak textured	dark walnut textured	gray oak textured***	tabac elm	anthracite elm	dark wenge		
Decor DRE-Cell 3	gray textured	black textured	toffee oak ...	Decor 3D			grand oak	elm	american walnut	ebony	polish oak 3D			
	white	noble white VVF7206	light gray	dark gray	concrete 1 F6462	concrete 2	gray oak	welsh oak	acacia	celini walnut	walnut	honey oak	chestnut	roasted walnut

*** decor available only in horizontal wood grain

ENTER/SOLID

REBATED DOOR LEAVES
interior entrance



*** door handle and upper backplate, set of patented cylinder - single key system.

STANDARD OPTIONS

- » door leaf frame made of MDF additionally reinforced with two flat metal bars
- » core made of perforated chipboard
- » external HDF board - flat or with decorative milling .
- » 3 silver screw-in pivot hinges
- » straight edge fig.1 or edge R 2,5 mm (in CPL laminate) fig. 2

REBATED DOOR LEAF MODEL ENTER:

- » bottom deadbolt lock adapted for door lock cylinder
- » upper deadbolt lock adapted for door lock cylinder
- » **Orders, in investment standard, will be executed after consultations with Untypical Orders Department. By investment standard, is defined door frame passage, with opened door leaf at 90 degree, interior entrance doors "80" 800 mm, "90" 900 mm.**

REBATED DOOR LEAF SOLID

- » multipoint mortise lock
- » hinges reinforced with anti-thrust bolts
- » **Orders, in investment standard, will be executed after consultations with Untypical Orders Department. By investment standard, is defined door frame passage, with opened door leaf at 90 degree, interior entrance doors "80" 800 mm, "90" 900 mm.**

APPLICATION

Door leaf ENTER and SOLID can be used as internal entrance door in multifamily and in public utility buildings.
It is recommended to use together with door leaf collection ENTER/SOLID fixed door frame ENTER/SOLID or fixed metal door frame.

CONSTRUCTION

Construction door leaf frame is made of MDF, additionally reinforced with two flat metal bars. Core is made of perforated chipboard. Door leaf unit has increased acoustic insulation (Rw=32dB). External HDF board is ennobled with DRE-Cell veneer - optional - flat finishing or decorative milling.

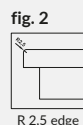
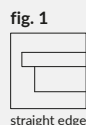

ENTER/SOLID 12 ENTER/SOLID 13 ENTER/SOLID 14 ENTER/SOLID 15 ENTER/SOLID 16 ENTER/SOLID 17



ENTER/SOLID 18 ENTER/SOLID 19* ENTER/SOLID 20* ENTER/SOLID 21** ENTER/SOLID 22** ENTER/SOLID 23**

* in models 19 and 20 veneer is glued in strips with variable wood grain.

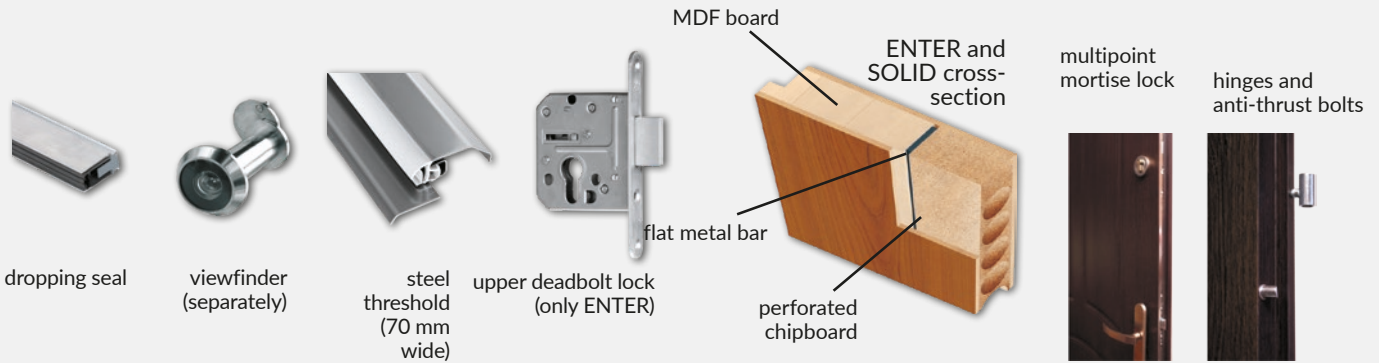

NOTE: ENTER 21-23 models and SOLID 21-23 models - door leaf in CPL laminate standard edge with radius R 2,5 mm. There is possibility to choose straight edge with edge band 1,5 mm thick (extra charge).

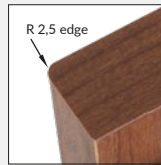
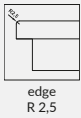

edge R 2,5 mm in CPL laminate



** in models 21-23 there are aluminum marrquetry elements installed in one surface of door leaf



Decor DRE-Cell 1	white (structure)	ash	beech	alder	golden oak	calvados	walnut	Decor DRE-Cell 2					white mat	silver
	white pine	siberian elm	sand oak	bleached oak textured	vintage oak	caramel walnut	golden oak textured	dark walnut textured	gray oak textured***	tabac elm	anthracite elm	dark wenge		
Decor DRE-Cell 3	gray textured	black textured	toffee oak	Decor 3D			grand oak	elm	american walnut	ebony	polish oak 3D			
Laminate CPL	white	noble white VVF7206	light gray	dark gray	concrete 1 F6462	concrete 2	gray oak	welsh oak	acacia	celini walnut	walnut	honey oak	chestnut	roasted walnut

*** Decor available only in horizontal wood grain

DOOR LEAF PRICES



SOLID RC2 - gray oak CPL

CPL Laminate	white	noble white VVF7206	light gray	gray dark	concrete 1 F6462	concrete 2	gray oak	welsh oak	acacia	celini walnut	walnut	honey oak	chestnut	roasted walnut
Available colours of fixed steel door frame	white mat	light gray mat	dark gray matt	brown mat	semi-gloss white	light gray semi-gloss	dark grey semi-gloss	brown semi-gloss	beige semi-gloss					
	RAL 9003	RAL 7047	RAL 7024	RAL 8017	RAL 9003	RAL 7047	RAL 7024	RAL 8017	RAL 1001					

Door frames colours are in two gloss scale (matt/low structure, semi gloss/plain).



STANDARD OPTION:

- » door leaf frame made of soft wood
- » core made of chipboard
- » straight edge with edge band 1,5 mm thick
- » multipoint mortise lock
- » 3 triple hinges
- » HDF external board with aluminum sheet

SOLID RC2 door leaves have acoustic insulation class $R_w=32dB$ and have anti-burglary class RC2 according to PN-EN 1627:2012. To comply with technical approval whole set must comprise of door leaf, steel door frame, steel threshold and purchased separately dedicated for this product hardware: door handle, backplate and cylinder patent inserts. Picture of door handle and backplate can be found on page 133.

APPLICATION

Door leaf SOLID RC2 can be used as interior entrance door in multifamily buildings and in public utility buildings.

OPTIONS AVAILABLE WITH EXTRA CHARGE

- » viewfinder - separately
- » door leaf „100”
- » steel threshold
- » ONTARIO door handle
- » ONTARIO backplate
- » patent insert (price for 2 pc)



SOLID RC2



threefold hinge E878

metal door frame cross-section

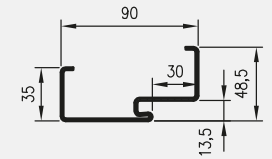

CONSTRUCTION OF DOOR FRAME

Metal welded door frame is made of low carbon steel sheet with 1,5 mm thickness. Door frame is powder coated and available in colours from RAL pallet: 1001 - beige semi gloss, 9003-white, 8017-brown, 7047-light gray, 7024-dark gray in two gloss scale (mat low structure/semi gloss). Both external side and internal side of door frame are secured with lacquered organic protective surface. On its one side there are made 4 holes for latch bolt and bolts installed in entrance DRE doors, and on the opposite side there are 3 sockets for hinges and anti-thrust bolts.

APPLICATION

Metal fixed door frame and metal hybrid door frame can be applied to interior entrance door leaf SOLID RC2. Door frame is designed to be assembled on finished floor level.

STANDARD OPTIONS

- sockets for 3 triple hinges E878
- additional sockets for anti-thrust bolts
- sockets for multi point lock latch Metalplast

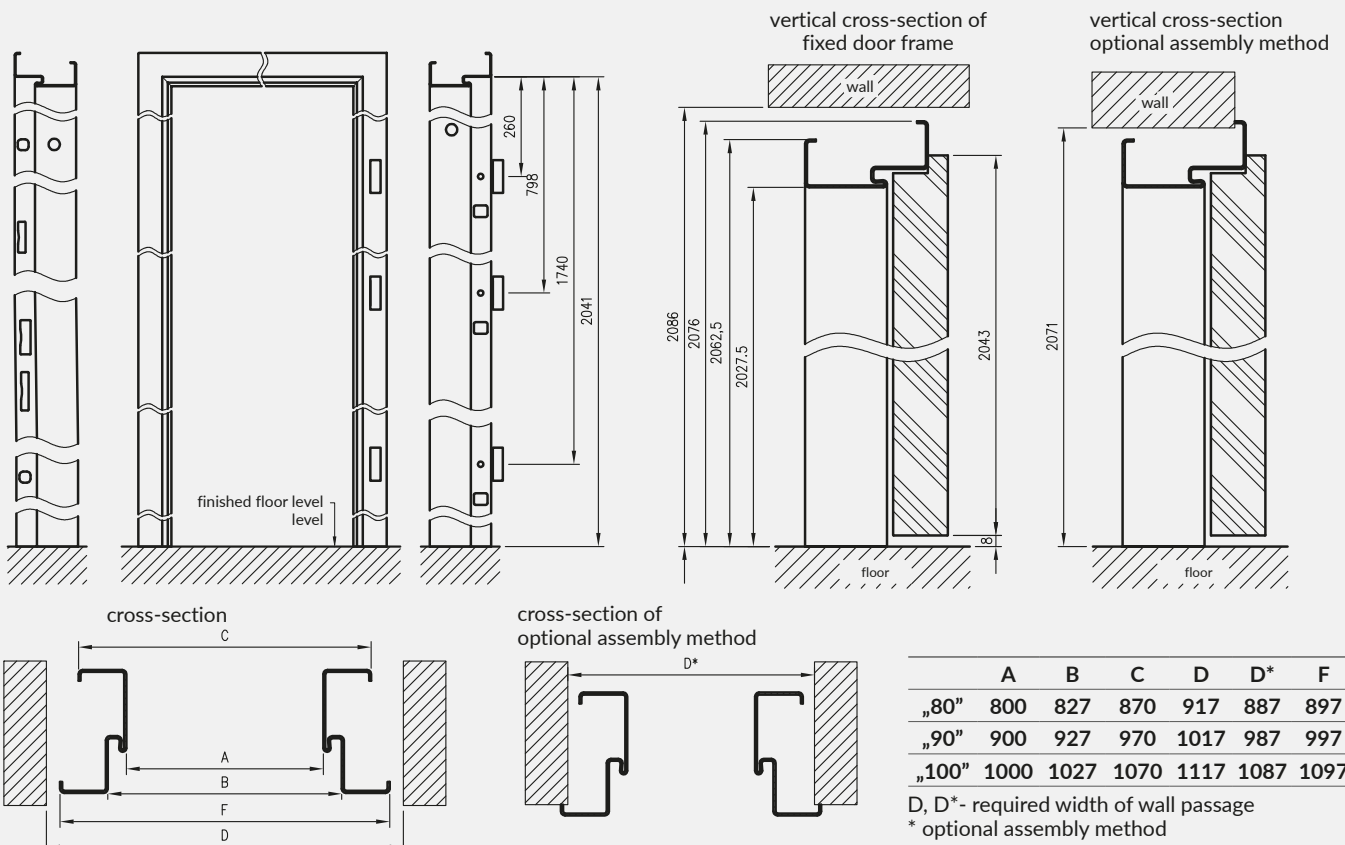

	A	B	C	D	D*	F
„80”	800	827	870	917	887	897
„90”	900	927	970	1017	987	997
„100”	1000	1027	1070	1117	1087	1097

D, D* - required width of wall passage
* optional assembly method

** required height of wall passage measured from the level of finished floor is 2086 mm or 2071* mm in optional assembly method
** height of passage in the door frame is 2027,5 mm



OLIMP 10 - white matt

Decor DRE-Cell	white (structure)	white mat	white pine	siberian elm	sand oak	bleached oak textured	ash	beech	alder	golden oak	calvados	golden oak textured		
	walnut	caramel walnut	dark walnut textured	gray oak textured***	tabac elm	anthracite elm	dark wenge	vintage oak	silver	gray textured	black textured	toffee oak ***		
Decor 3D	elm	american walnut	ebony	polish oak 3D	grand oak									
CPL Laminate	white	noble white VVF7206	light gray	dark gray	concrete 1 F6462	concrete 2	gray oak	welsh oak	acacia	celini walnut	walnut	honey oak	chestnut	roasted walnut

*** Decor available only in horizontal wood grain

STANDARD OPTIONS

- » core made of Halspan chipboard 44 mm in EI30 or 54 mm in EI60 with additional pine wood strips attached circumferentially
- » straight edge, rounded glazing bar **fig.1**
- » transparent fire - resistance glass pane (variable width dependent on the size of the door leaf)
- » intumescent smoke-proof gasket
- » 3 hinges
- » patented cylinder lock
- » dropping seal

fig. 1

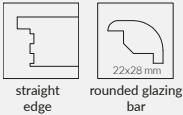

Acoustic sound insulation rate for single leaf door $R_w=32$ dB
Acoustic sound insulation rate for double leaf door $R_w=27$ dB



fire resistance ventilation grille.

OPTIONS AVAILABLE WITH EXTRA CHARGE

- » viewfinder
- » selfcloser DORMA
- » selfcloser GEZE
- » fire resistance ventilation grille.
- » surcharge for passive door leaf

APPLICATION

Fire-resistance doors are used as interior entrance doors in residential housing, public utility buildings and collective residential buildings. In order to comply with the conditions of the National Technical Assessment self closer should be applied in doors with fire-resistance EI30 and EI60.

Doors are sold only as a set with a metal fire-resistance door frame.



SELFCLOSER DORMA



SELFCLOSER GEZE

NOTE: In door leaf with fire-resistance EI30 there are used three triple hinges, while in door leaf with fire resistance EI60 there are used VX7939 hinges.



OLIMP 10



OLIMP 20

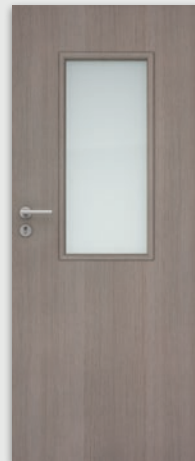

OLIMP 30

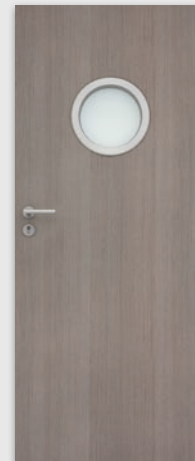

OLIMP 40

METAL FIRE RESISTANT DOOR FRAME

CONSTRUCTION

Metal door frame is made of carbon steel construction plate with a minimum thickness 1,5 mm, structure is welded and powder-coated in brown or white colour.

APPLICATION

Door frame is applied to interior entrance fire-resistance doors OLIMP EI30 and EI60.

STANDARD OPTIONS

- » 3 hinges
- » gasket with enhanced flame-resistance properties

metal door frame for triple hinges

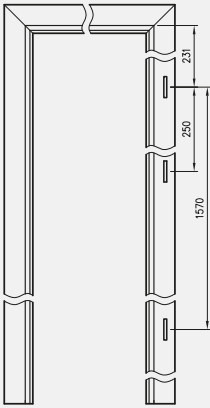

metal door frame for hinges VX 7939

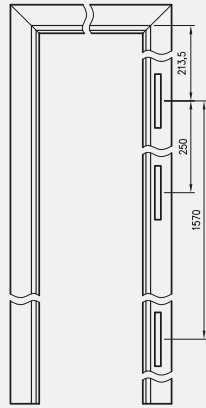

Cross-section of a metal door frame for OLIMP door leaf

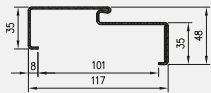

Vertical cross-section assembled by using mineral wool

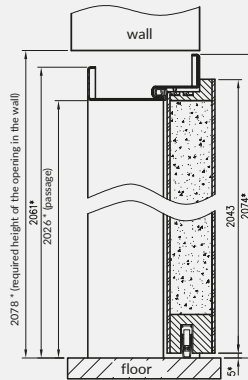

Vertical cross-section assembled by using concrete mortar

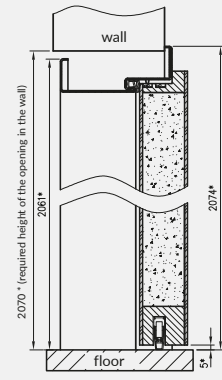

* dimensions for EI30 doors, for EI60, add 1 mm.

assembly cross-section by using mineral wool

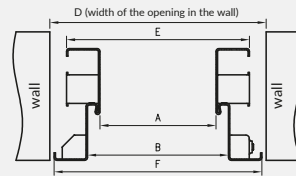

assembly cross-section by using concrete mortar

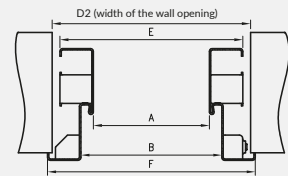

Dimensions for single leaf EI30

	A	B	D	D2	E	F
„80”	800	826	905	888	870	896
„90”	900	926	1005	988	970	996
„90E”	915	941	1020	1003	985	1011
„100”	1000	1026	1105	1088	1070	1096
„110”	1100	1126	1205	1188	1170	1196

Dimensions for single leaf EI60

	A	B	D	D2	E	F
„80”	801	827	906	889	871	897
„90”	901	927	1006	989	971	997
„90E”	926	952	1031	1014	996	1022
„100”	1001	1027	1106	1089	1071	1097
„110”	1101	1127	1206	1189	1171	1197

Dimensions for EI30 double leaf doors

	A	B	D	D2	E	F
„160”	1635	1661	1740	1723	1705	1731
„170”	1735	1761	1840	1823	1805	1831
„180”	1835	1861	1940	1923	1905	1931
„190”	1935	1961	2040	2023	2005	2031
„200”	2035	2061	2140	2123	2105	2131
„210”	2135	2161	2240	2223	2205	2231
„220”	2235	2261	2340	2323	2305	2331

Dimensions for EI60 double leaf doors

	A	B	D	D2	E	F
„160”	1636	1662	1741	1724	1706	1732
„170”	1736	1762	1841	1824	1806	1832
„180” = „90” + „90”	1836	1862	1941	1924	1906	1932
„200” = „100” + „100”	2036	2062	2141	2124	2106	2132
„210”	2136	2162	2241	2224	2206	2232
„220”	2236	2262	2341	2324	2306	2332

price of single door leaf = price of the active door leaf + price of the fire resistance metal door frame.

price of double leaf door = price of the active door leaf + price of the passive door leaf (active door leaf + additional charge) + price of the fire resistant metal door frame.



FIRE RESISTANT DOOR LEAVES ATHOS

REBATED
Interior entrance door leaves

ATHOS TECHNICAL DOORS MEET THE FOLLOWING REQUIREMENTS:

- » fire resistance class: EI₂30
- » smoke proof class: Sa, S₂₀₀
- » mechanical resistance class: 3
- » sound insulation class: RW=32 dB

APPLICATION

Interior entrance fire-resistance doors, are used in residential housing, public utility buildings and collective residential buildings, as well as commercial and technical premises. Doors are sold only as a complete set with a metal door frame and dropping seal.

STANDARD OPTION

- » door leaf frame made of soft wood
- » core made of chipboard
- » straight edge
- » single-point mortise lock adapted for cylinder lock
- » 3 triple hinges

DOOR FRAMES

- » fixed metal door frame p. 146
- » adjustable metal door frame p.147
- » steel hybrid door frame p.148

OPTIONS AVAILABLE WITH EXTRA CHARGE

- » selfcloser DORMA
- » selfcloser GEZE
- » door leaf "100" - "110"
- » viewfinder

In order to comply with the conditions of the National Technical Assessment, doors with fire resistance EI 30 should be equipped with a self closer.

The price of the set is from - includes: door leaf, steel fixed door frame and dropping seal.

NOTE: To the price of door leaf unit it should be added price of steel door frame.

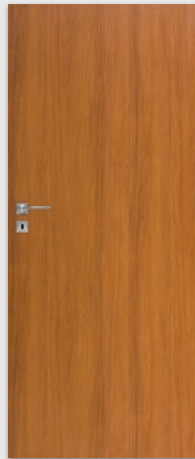

ATHOS 10

white (structure)	white mat	white pine	siberian elm	sand oak	bleached oak textured	ash	beech	alder	golden oak	calvados	golden oak textured	caramel walnut	Decor DRE-Cell	
		gray textured	black textured	toffee oak ...	silver	walnut	dark walnut textured	gray oak textured***	tabac elm	anthracite elm	dark wenge	vintage oak		
								elm	american walnut	ebony	polish oak 3D	grand oak	Decor 3D	
white	noble white VVF7206	light gray	gray dark	concrete 1 F6462	concrete 2	gray oak	welsh oak	acacia	celini walnut	walnut	honey oak	chestnut	roasted walnut	CPL Laminate

*** Decor available only in horizontal wood grain

FORCA TECHNICAL DOORS MEET THE FOLLOWING REQUIREMENTS:

- » class of anti-burglary: RC3 (according to PN-EN 1627: 2012)
- » fire resistance class: EI₂30
- » smoke proof class: Sa, S₂₀₀
- » mechanical resistance class: 3
- » sound insulation class: RW=32 dB

APPLICATION

Interior entrance, fire resistance and anti-burglary doors are used in residential housing, public utility buildings and collective residential buildings as well as commercial and technical premises. Doors are sold only as a complete set with metal door frame, metal threshold, door handle, backplate and two patented cylinder inserts.

STANDARD OPTION

- » door leaf frame made of soft wood
- » core made of chipboard
- » straight edge
- » steel strings
- » 5-point mortise lock
- » 3 triple hinges

DOOR FRAMES

- » fixed metal door frame p. 146
- » adjustable metal door frame p.147
- » steel hybrid door frame p.148

OPTIONS AVAILABLE WITH EXTRA CHARGE

- » steel threshold
- » handle
- » longitudinal backplate
- » patent cylinder x 2 pcs.
- » selfcloser DORMA
- » selfcloser GEZE
- » door leaf "100"
- » viewfinder

In order to comply with the conditions of the National Technical Assessment for doors with EI 30 fire resistance and anti-burglary properties, doors should be equipped with a self closer and DIVA door handle with the backplate. Picture of door handle and backplate - p. 133.

Price for the set from - includes: door leaf, fixed metal door frame, steel threshold, door handle / door handle and DIVA backplate without insert protection and two patent inserts.

NOTE: To the price of door leaf unit it should be added price of steel door frame, steel threshold, handle, backplate and price of two patent cylinders.



FORCA 10

Decor DRE-Cell	white (structure)	white mat	white pine	siberian elm	sand oak	bleached oak textured	ash	beech	alder	golden oak	calvados	golden oak textured		
	walnut	caramel walnut	dark walnut textured	gray oak textured***	tabac elm	anthracite elm	dark wenge	vintage oak	silver	gray textured	black textured	toffee oak***		
Decor 3D	elm	american walnut	ebony	polish oak 3D	grand oak									
CPL Laminate	white	noble white VF7206	light gray	gray dark	concrete 1 F6462	concrete 2	gray oak	welsh oak	acacia	celini walnut	walnut	honey oak	chestnut	roasted walnut

*** decor available only in horizontal wood grain

FORCA B TECHNICAL DOORS MEET THE FOLLOWING REQUIREMENTS:

- » class of anti-burglary:
RC3 (according to PN-EN 1627: 2012)
- » mechanical resistance class: 3
- » sound insulation class: RW=32 dB

APPLICATION

Interior entrance, fire resistance and anti-burglary doors are used in residential housing, public utility buildings and collective residential buildings as well as commercial and technical premises. Doors are sold only as a complete set with metal door frame, metal threshold, door handle, backplate and two patented cylinder inserts.

STANDARD OPTION

- » door leaf frame made of soft wood
- » core made of chipboard
- » straight edge
- » steel strings
- » 5-point mortise lock
- » 3 triple hinges

DOOR FRAMES

- » fixed metal door frame p. 146
- » adjustable metal door frame p.147
- » steel hybrid door frame p.148

OPTIONS AVAILABLE WITH EXTRA CHARGE

- » steel threshold
- » handle
- » longitudinal backplate
- » patent cylinder x 2 pcs.
- » door leaf "100"
- » viewfinder

Price for the set from includes: door leaf, fixed metal door frame, metal threshold, door handle / door handle and DIVA backplate without insert protection and two patent inserts.

NOTE: To the price of door leaf unit it should be added price of steel door frame, steel threshold, handle, backplate and price of two patent cylinders..



FORCAB 10

Decor DRE-Cell	white (structure)	white mat	white pine	siberian elm	sand oak	bleached oak textured	ash	beech	alder	golden oak	calvados	golden oak textured		
	walnut	caramel walnut	dark walnut textured	gray oak textured***	tabac elm	anthracite elm	dark wenge	vintage oak	silver	gray textured	black textured	toffee oak ***		
Decor 3D	elm	american walnut	ebony	polish oak 3D	grand oak									
CPL Laminate	white	noble white VVF7206	light gray	gray dark	concrete 1 F6462	concrete 2	gray oak	welsh oak	acacia	celini walnut	walnut	honey oak	chestnut	roasted walnut

*** decor available only in horizontal wood grain

FIXED METAL DOOR FRAME

FOR FORCA / FORCA B / ATHOS DOOR LEAVES

CONSTRUCTION

Metal welded door frame is made of steel low carbon sheet with 1,5 mm thickness. Door frame is powder coated and available in colours from RAL pallet: 1001 - beige semi gloss, 9003-white, 8017-brown, 7047-light gray, 7024-dark gray in two gloss scale (mat low structure/semi gloss). Both external side and internal side of door frame are secured with lacquered organic protective surface. On its one side there are made 4 holes for latch bolt and bolts installed in entrance DRE doors, and on the opposite side there are 3 sockets for hinges and anti-thrust bolts.

APPLICATION

Metal fixed door frame and metal hybrid door frame can be applied to technical door leaves FORCA, FORCA B and ATHOS. Door frame is designed to be assembled on finished floor level.

STANDARD OPTIONS

- » sockets for 3 hinges
- » additional sockets for anti-thrust bolts
- » sockets for latch plates of five point mortise lock (FORCA, FORCA B)
- » socket for latch plate of main lock (ATHOS)

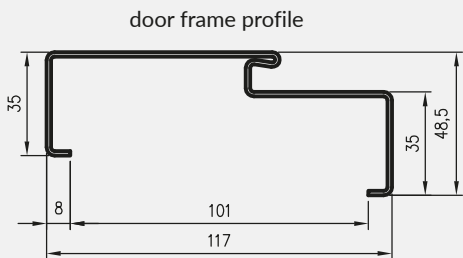

horizontal cross-section of door frame mounted in the wall

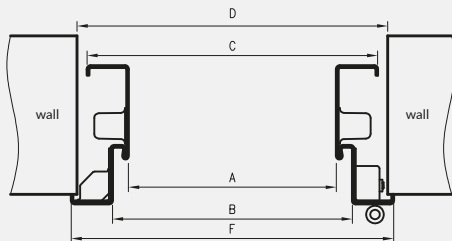

vertical cross-section

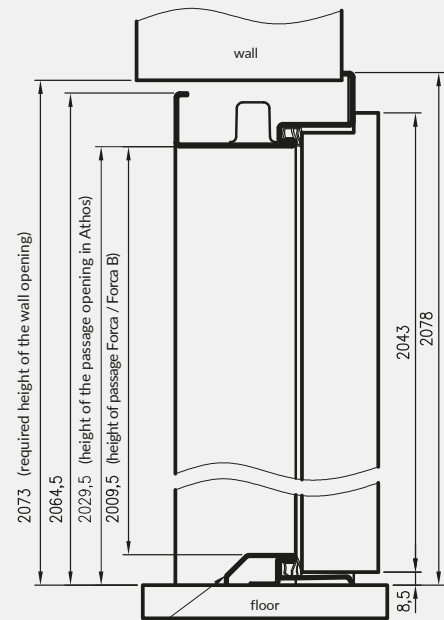

Fixed (steel) threshold for Forca and Forca B door leaves or dropping seal in Athos door leaves

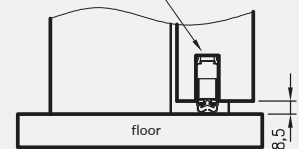

Available colours of fixed steel door frame

RAL 9003	RAL 7047	RAL 7024	RAL 8017	RAL 9003	RAL 7047	RAL 7024	RAL 8017	RAL 1001

Door frames colours are in two gloss scale (matt/low structure, semi gloss/plain).

** beige colour available only in semi-gloss

	A	B	D	C	F
„80”	800	827	887	870	897
„90”	900	927	987	970	997
„90E”	915	942	1002	985	1012
„100”	1000	1027	1087	1070	1097
„110” *	1100	1127	1187	1170	1197

* width available only in ATHOS collection

ADJUSTABLE METAL DOOR FRAME

FOR FORCA / FORCA B / ATHOS DOOR LEAVES

CONSTRUCTION

Adjustable metal door frame is made of low-carbon steel sheet with a thickness of 1.5 mm. Vertical element and lintel they are permanently welded together. Door frame is powder coated and available in colours from RAL pallet: 9003-white, 8017-brown, 1001-beige, 7047-light gray, 7024-dark gray in two gloss scale (mat / low structure, semi-gloss / plain). Both external side and internal side of door frame are secured with lacquered organic protective surface. On its one side there are made 4 holes for latch bolt and bolts installed in entrance DRE doors, and on the opposite side there are 3 sockets for hinges and anti-thrust bolts.

APPLICATION

Adjustable metal door frames can be applied to technical door leaves FORCA, FORCA B and ATHOS. It is intended to be installed on finished floor level.

STANDARD OPTIONS

- » sockets for 3 hinges
- » additional sockets for anti-thrust bolts
- » sockets for latch plates of five point mortise lock (FORCA, FORCA B)
- » socket for latch plate of main lock (ATHOS)

horizontal cross-section of door frame mounted in the wall

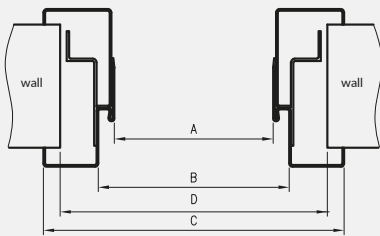

door frame profile

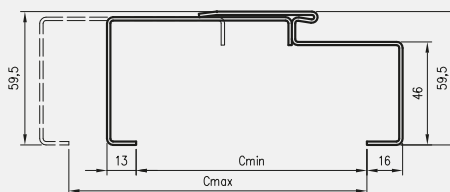

for single-leaf doors

n	Cmin	Cmax
1	103	133
2	133	163
3	163	193
4	193	223
5	223	253
6	253	283
7	283	313

for single-leaf doors

width	A	B	C	D
80	800	827	919	890
90	900	927	1019	990
90E	915	942	1034	1005
100	1000	1027	1119	1090
110*	1100	1127	1219	1190

* width available only in the ATHOS collection



cross-section of an adjustable steel door frame

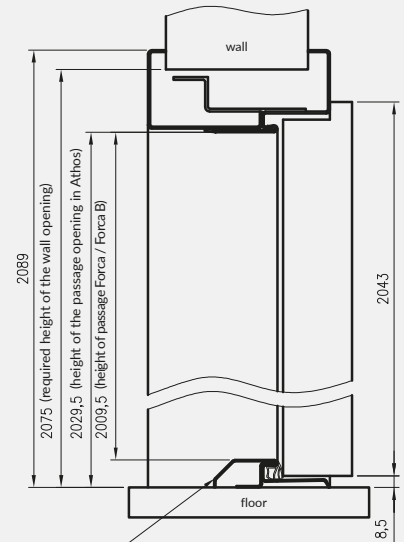

Fixed (steel) threshold for Forca and Forca B door leaves or dropping seal in Athos door leaves

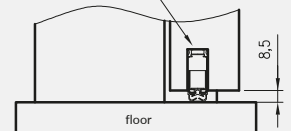

white semi-gloss	light gray semi-gloss	dark gray semi-gloss	brown semi-gloss	beige semi-gloss**	Colours of metal adjustable door frame
RAL 9003	RAL 7047	RAL 7024	RAL 8017	RAL 1001	
white mat	light gray mat	dark gray mat	brown mat		
RAL 9003	RAL 7047	RAL 7024	RAL 8017		

Door frames colours are in two gloss scale (mat/low structure, semi gloss/plain).

** beige colour available only in semi-gloss

STEEL HYBRID DOOR FRAME

FOR FORCA / FORCA B / ATHOS DOOR LEAVES



Steel hybrid door frame - it is an innovative solution in our sale offer, which combine solidity of metal construction with additional functionality it allows to finish wall passage by using door frame elements made of MDF, coated with CPL laminate.

Hybrid metal door frame it is combination of metal door frame with fixed width, MDF panel available in 11 optional variants of width and masking architrave. This solution allows to finish walls with thickness ranging between 145-345 mm, and additional possible adjustment up to 20 mm.

APPLICATION:

Hybrid door frame is designed to be used for technical door leaves FORCA, FORCA B, ATHOS. It is intended to be installed on finish floor level.

horizontal cross-section of door frame mounted in the wall

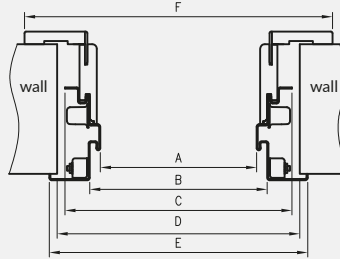

door frame profile

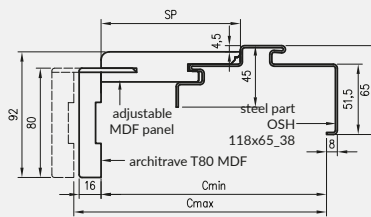

vertical cross-section

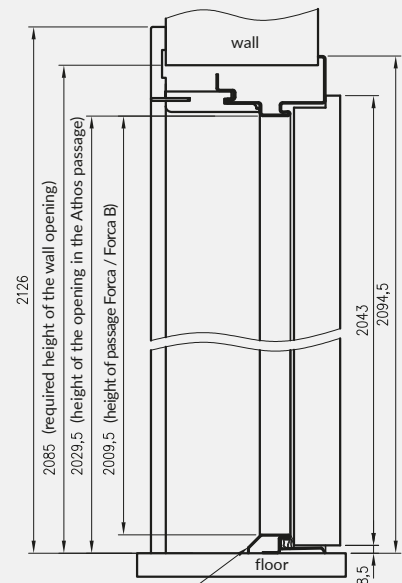

Fixed threshold (steel) for Forca/Forca B door leaf or dropping seal in Athos door leaf

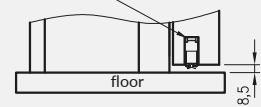

option	Cmin	Cmax	SP
1	145	165	82
2	165	185	102
3	185	205	122
4	205	225	142
5	225	245	162
6	245	265	182
7	265	285	202
8	285	305	222
9	305	325	242
10	325	345	262
11	345	365	282

Dimensions of the door frame width

width	A	B	C	D	E	F
80	800	827	890	910	930	993
90	900	927	990	1010	1030	1093
90E	915	942	1005	1025	1045	1108
100	1000	1027	1090	1110	1130	1193
110*	1100	1127	1190	1210	1230	1293

* width available only in the ATHOS collection

CPL Laminate

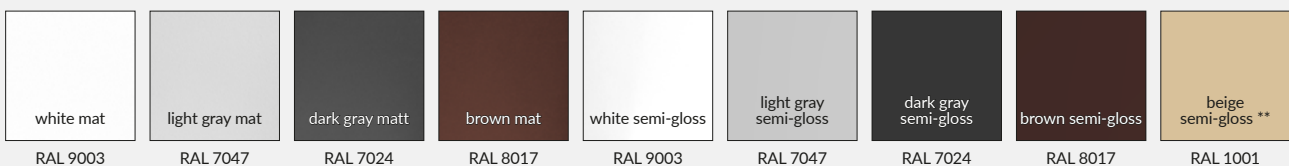

Colors in two gloss scale (matte / low structure, semi-gloss / plain).

** beige colour available only in semi-gloss



GALLA 1
transparent



GALLA 1
decormat



GALLA 1
decormat brown



GALLA 1
decormat graphite



GALLA 2
sand blasted glass
transparent strips

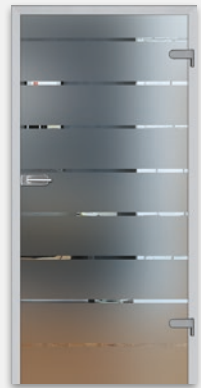

GALLA 3
sand blasted glass
transparent strips



GALLA 10
decormat
screen printing



GALLA 10
transparent glass
screen printing



GALLA 11
decormat
screen printing

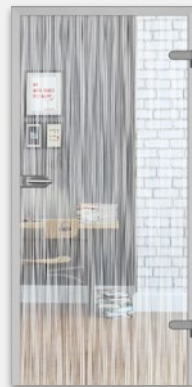

GALLA 11
transparent glass
screen printing



GALLA 12
decormat
screen printing



GALLA 13
decormat
screen printing

Door leaf is made of tempered, 8mm glass pane.

OPTIONS AVAILABLE WITH EXTRA CHARGE

- » ventilation undercut available in swing door leaf
(door leaf „80” and „90” meet ventilation requirements)



GRACCA 1



GRACCA 2



GRACCA 3



GRACCA 3
transparent

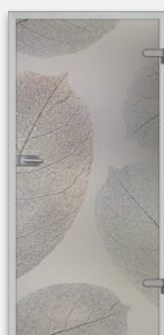

GRACCA 4



GRACCA 5



GRACCA 6



GRACCA 6
transparent



GRACCA 7



GRACCA 8



GRACCA 9



GRACCA 10



GRACCA 11



GRACCA 12



GRACCA 13



GRACCA 14
transparent



GRACCA 15



GRACCA 16



GRACCA 17



GRACCA 18



GRACCA 19



GRACCA 20



GRACCA 21



GRACCA 22

OPTIONS AVAILABLE WITH EXTRA CHARGE

» ventilation undercut available in active door leaf
(door leaf „80” and „90” meet ventilation requirements)

Door leaf is made of tempered, 8mm glass pane with ceramic, permanent digital printing presented on particular model.



GOSSA 1

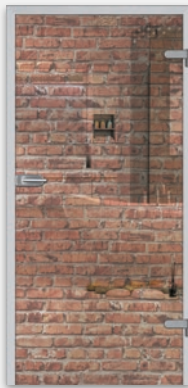

GOSSA 1
transparent



GOSSA 2

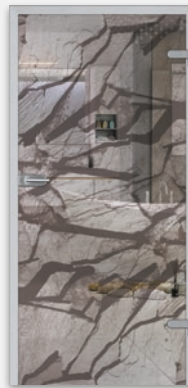

GOSSA 2
transparent



GOSSA 3



GOSSA 3
transparent



GOSSA 4



GOSSA 4
transparent

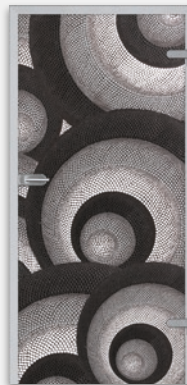

GOSSA 5



GOSSA 5
transparent



GOSSA 6



GOSSA 6
transparent



GOSSA 7



GOSSA 7
transparent



GOSSA 8



GOSSA 9
transparent



GOSSA 10



GOSSA 11

OPTIONS AVAILABLE WITH EXTRA CHARGE

» ventilation undercut available in active door leaf
(door leaf „80” and „90” meet ventilation requirements)

Door leaf is made of laminated glass which consist of two tempered 4 mm glass panes glued together by foil with high quality printing.



GOSSA 12



GOSSA 13



GOSSA 14



GOSSA 15



GOSSA 16
transparent



GOSSA 17



GOSSA 18



GOSSA 19

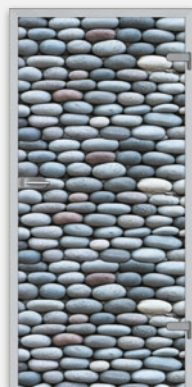

GOSSA 20



GOSSA 21



GOSSA 22

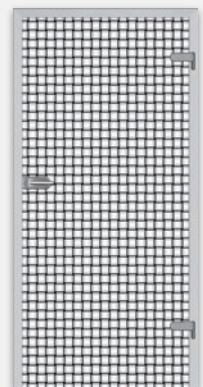

GOSSA 23



GOSSA 24



GOSSA 25



GOSSA 26



GOSSA 27

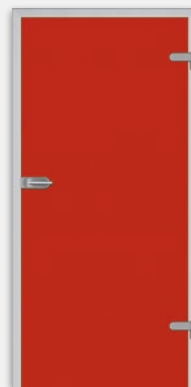

GOSSA 28

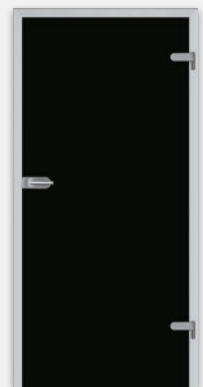

GOSSA 29

OPTIONS AVAILABLE WITH EXTRA CHARGE

» ventilation undercut available in active door leaf
(door leaf „80” and „90” meet ventilation requirements)

Door leaf is made of laminated glass which consist of two tempered 4 mm glass panes glued together by foil with high quality printing.

Models GOSSA 26-29 - door leaf is made of laminated glass which consist of two tempered 4mm, painted glass panes glued together by foil.

DOOR LEAF DIMENSIONS AND PLACEMENT OF HARDWARE

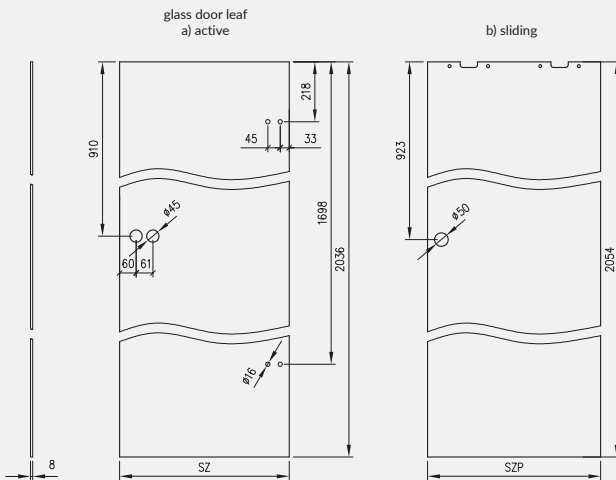

Door leaf unit is made of safe, plain or glued, tempered 8mm glass pane which has in standard option holes for assembly of:

- » hinges and lock in active doors leaf
- » round door handle and hardware adapted for sliding system door leaf

APPLICATION

Glass door leaf are used as interior doors in residential housing, public utility buildings and collective residential buildings.

OPENING DIRECTION OF GLASS DOOR LEAF

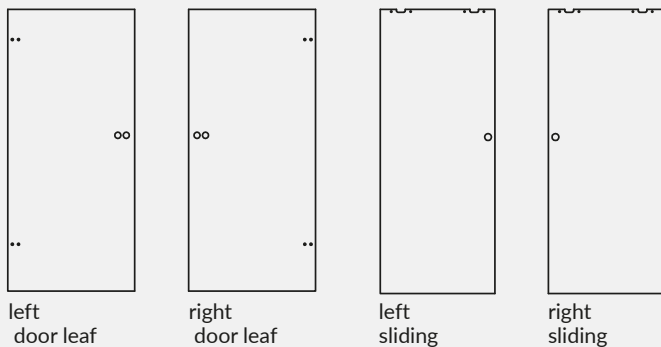

GALLA and GRACCA collections have obverse and reverse side. GOSSA collection has uniform pattern on both sides, visible surfaces of door leaf are plain.

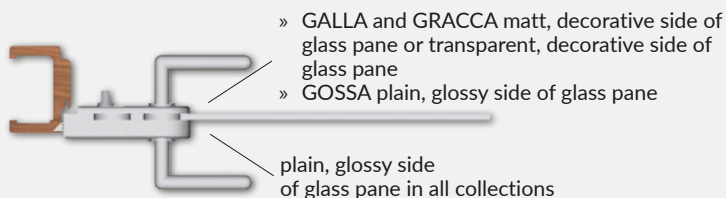

SELECTION OF LOCKS FOR GLASS DOORS

Depending on door leaf opening direction (left/right): GEZE toilet locks and all Metalbud locks are configured, to left doors - left locks are used, to right doors - right locks are used remaining door locks are universal use (they can be configured left or right). In toilet lock it is necessary to choose one of the following combinations which present assembly situation (difference is in door leaf opening direction and/or placement of toilet blockage):

DOOR LEAF WIDTH

Symbol of the door dimension	SZ	SZP
„60”	617	630
„70”	717	730
„80”	817	830
„90”	917	930

SZ - width of glass swing door leaf

SZP - width of glass sliding door leaf

DOOR LEAF HEIGHT

2036 mm - height of glass active door leaf

2054 mm - height of glass sliding door leaf

NOTE: . There is no possibility to shorten glass door leaf.

CLEARANCE BETWEEN DOOR LEAF AND FLOOR

Standard clearance between door leaf unit and ready floor is 8 mm.

NOTES REFERRED TO HINGES

DOOR FRAMES applied to glass doors should be equipped with two pivot \varnothing 15 mm.

FULFILMENT OF VENTILATION REQUIREMENTS FOR GLASS DOORS

symbol dim. DOORS	doors with ventilation undercut	
	ventilation surface of the undercut and the clearance 8 mm [m ²]	required clearance to meet ventilation requirements [in mm]
„90”	0,027	2
„80”	0,024	5,5
„70”	0,021	10*
„60”	0,017	16*

* - door leaf „60” and „70” doesnt meet ventilation requirements.

Ventilation undercut (only swing door leaf)

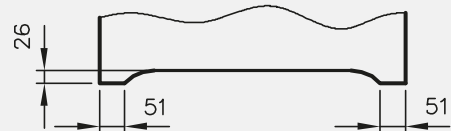

Use of ventilation undercut in door leaf unit with width "80" - "90" and standard clearance between door leaf and floor (8mm) will fulfill ventilation requirement - total ventilation surface 0,022 m².

HARDWARE FOR GLASS DOORS

DOOR LEAVES

fig. 1 right door leaf /blockade outside

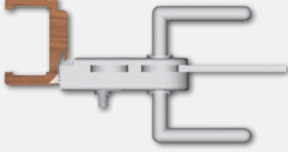

Geze and Metalbud toilet locks - select right toilet lock outside.
remaining locks - select left lock*

fig. 2 left door leaf/blockade outside

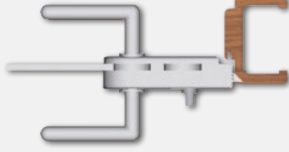

Geze and Metalbud toilet locks - select left toilet lock outside.
remaining locks - select left lock*

fig. 3 right door leaf/blockade inside

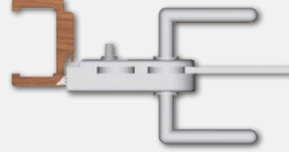

Geze and Metalbud toilet locks - select right toilet lock inside.
remaining locks - select right lock*



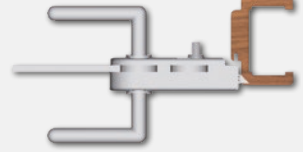





















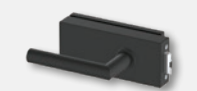



fig. 4 left door leaf/blockade inside



Geze and Metalbud toilet locks - select left toilet lock inside.
remaining locks - select right lock*

* In toilet locks, except Geze and metalbud locks, definition "left", "right" refers to placement of toilet blockade: description "left lock" means that blockade is placed on exterior side of the door leaf, description "right lock" means that blockade is placed on interior side of the door leaf.

HARDWARE

				
aluminum lock	aluminum toilet lock***	aluminum simple key lock	aluminum lock cylinder lock**	aluminum hinge
				
GEZE lock	GEZE toilet lock***	GEZE simple key lock	GEZE cylinder lock**	GEZE hinge
				
steel lock	steel toilet lock***	steel simple key lock	steel cylinder lock**	steel hinge
				
steel lock Metal-Bud	steel toilet lock*** Metal-Bud	steel simple key lock Metal-Bud	steel cylinder lock** Metal-Bud	steel hinge Metal-Bud
				
steel lock Metal-Bud rounded	steel toilet lock*** Metal-Bud rounded	simple key steel lock Metal-Bud rounded	steel cylinder lock** Metal-Bud rounded	steel hinge Metal-Bud rounded
				
black rectangular door lock Metal-Bud	black rectangular toilet lock Metal-Bud	black rectangular simple key lock Metal-Bud	key black rectangular cylinder lock Metal-Bud	rectangular black hinge Metal-Bud

** It is necessary to purchase patented cylinder 21/26 separately (see details in the table above)

** Toilet lock - selection of toilet lock see details above

FIXED DOOR FRAMES

REBATED

CONSTRUCTION

Fixed door frame is made of high-quality MDF board and it is coated with ecological, wood-like decorative DRE-Cell veneer, 3D veneer, 0,15 - 0,20 mm CPL, finish veneer or natural veneer.

Door frames has fixed width 100 mm.

APPLICATION

Fixed door frame can be used in the following types of doors:

- » ENTER entrance doors (equipped with 3 \varnothing 13,5 mm hinges and additional upper latch plate)
- » SOLID entrance doors (equipped with 3 \varnothing 13,5 mm hinges and 4 hooks for the latch and latches of the flat multi-point lock)
- » glass doors ("OPC" they are equipped with two hinges \varnothing 15 mm, special latch plate and rubber seal strip)
- » other remaining rebated door leaf (there are used 2 or 3 \varnothing 13,5 mm hinges, in all frame construction door and panel door collections in size "90" and wider; door frames should be equipped with 3 hinges)

Masking strips are used in fixed door frames and SOFT door frames, whereas for the fixed SOFT natura door frames angular architrave are used.

THE SET CONTAINS

Main beam (one horizontal and two vertical elements), door gasket, a set of hinges, all necessary components for the installation of door frames in accordance with the supplied instruction. Door frames are packed in cardboard boxes.



Fixed door frame

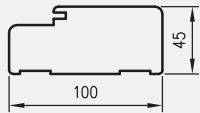

fixed door frame SOFT

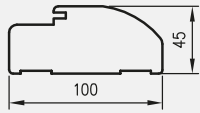

fixed door frame SOFT natura

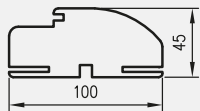

vertical cross-section of rebated door leaf

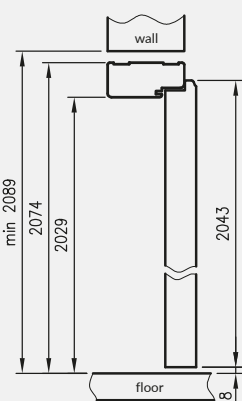

vertical cross-section glass doors

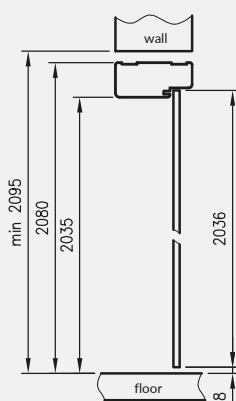

required height of wall passage 2089 mm
(2095 mm for glass doors)

* in case of three hinges

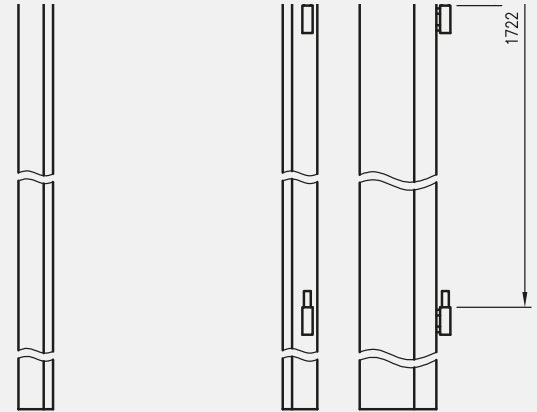

horizontal cross-section of fixed door frame

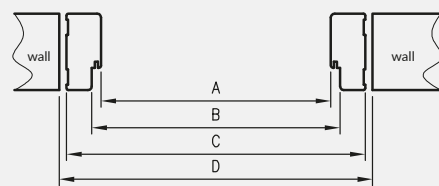

for single-leaf doors

	A	B	C	D
60	600	624	690	712
70	700	724	790	812
80	800	824	890	912
90	900	924	990	1012
100	1000	1024	1090	1112
110	1100	1124	1190	1212

for double-leaf doors

	A	B	C	D
100d	1035	1059	1125	1147
110d	1135	1159	1225	1247
120	1235	1259	1325	1347
130	1335	1359	1425	1447
140	1435	1459	1525	1547
150	1535	1559	1625	1647
160	1635	1659	1725	1747
170	1735	1759	1825	1847
180	1835	1859	1925	1947
190	1935	1959	2025	2047
200	2035	2059	2125	2147

OPTIONS AVAILABLE WITH EXTRA CHARGE

- » door frame ENTER (with latch deadbolt plate)
- » door frame SOLID
- » door frame for double leaf door:

+30%

FIXED DOOR FRAMES

NON-REBATED

CONSTRUCTION

Fixed non-rebated door frame is made of high-quality MDF board and it is coated with ecological, wood-like decorative DRE-Cell veneer, 3D veneer, 0,15 - 0,20 mm CPL, finish veneer or natural veneer.

Door frames has fixed width 100 mm.

APPLICATION

Fixed non-rebated door frame can be applied to all DRE collections which are available in non-rebated option.

SET CONTAINS

Main beam (one horizontal and two vertical elements), door gasket, a set of hinges, all necessary components for the installation of door frames in accordance with the supplied instruction. Door frames are packed in cardboard boxes.



vertical cross-section
OPB non-rebated door leaves

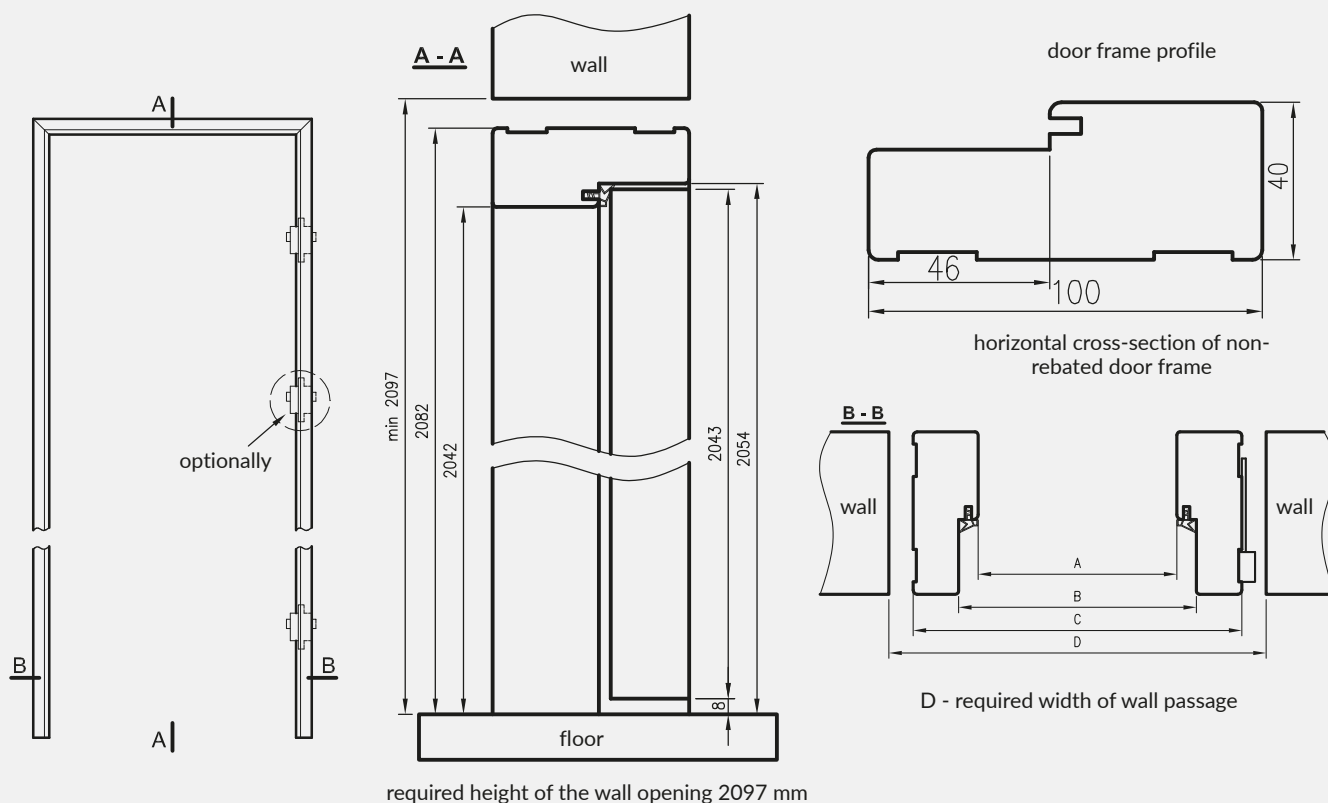

for single-leaf doors

	A	B	C	D
60	627	651	707	730
70	727	751	807	830
80	827	851	907	930
90	927	951	1007	1030
100	1027	1051	1107	1130

for double-leaf doors

	A	B	C	D
120	1274	1298	1354	1380
130	1374	1398	1454	1480
140	1474	1498	1554	1580
150	1574	1598	1654	1680
160	1674	1698	1754	1780
170	1774	1798	1854	1880
180	1874	1898	1954	1980

Prices include 2 hinges with assembly plates.

Price of the double-leaf door frame: + 50% (if 3 hinges are used, there is additional payment)

» Additional payment for the third hinge Estetic 80

ADJUSTABLE DOOR FRAMES

WITH K63 AND N63 ANGULAR ARCHITRAVE

CONSTRUCTION

Adjustable door frame is made of a high-quality wood-based MDF board. On its visual side it is entirely coated with a decorative wood-imitation DRE-Cell veneer, 3D veneer, Finish foil, painted ** - in configuration with K63 architrave or natural veneer in configuration with N63 architrave. Its construction allows to be used on walls with span between 75-320 mm thick.

**NOTE: To ensure the highest quality of painted door frames, before painting process, they are coated with special material which constitutes solid base.

APPLICATION

Adjustable door frame can be applied for:

- » interior rebated door leaf (in all frame construction door and panel door collections in size "90" and wider, door frames should be equipped with three hinges \varnothing 13,5 mm).
- » entrance doors ENTER (includes 3 hinges \varnothing 13, 5 mm, additional latch plate - extra charge 20 PLN net)
- » glass door ("ORC" they are equipped with two hinges \varnothing 15 mm, special latch plate and rubber gasket).

SET CONTAINS

Main beam (one horizontal and two vertical elements together with masking elements), door seal, set of hinges, all necessary components for the installation of door frames in accordance with the supplied instruction. Door frames are packed in cardboard boxes.



OR/ORC cross-section with K63 architrave

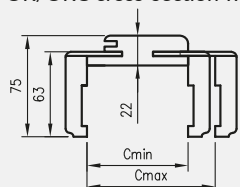

OR/ORC cross-section Natura with N63 architrave

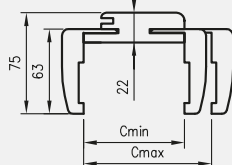

vertical cross-section of rebated door leaves

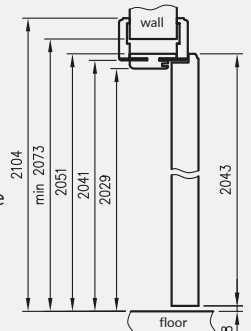

required wall passage height 2073 mm (2079 mm for glass doors)

vertical cross-section of glass doors

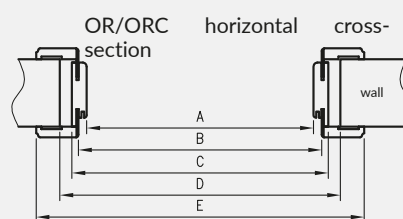
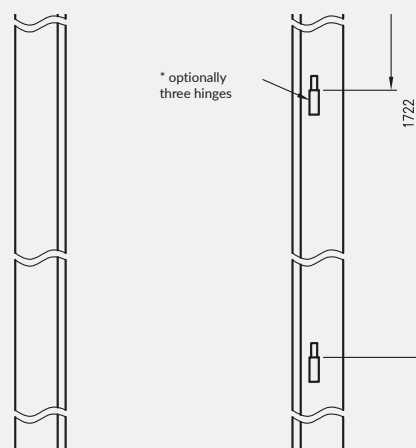
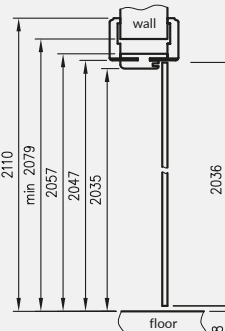

for single-leaf doors

	A	B	C	D	E
60	600	624	644	680	750
70	700	724	744	780	850
80	800	824	844	880	950
90	900	924	944	980	1050
100	1000	1024	1044	1080	1150
110	1100	1124	1144	1180	1250

for double-leaf doors

	A	B	C	D	E
100d	1035	1059	1079	1115	1185
110d	1135	1159	1179	1215	1285
120	1235	1259	1279	1315	1385
130	1335	1359	1379	1415	1485
140	1435	1459	1479	1515	1585
150	1535	1559	1579	1615	1685
160	1635	1659	1679	1715	1785
170	1735	1759	1779	1815	1885
180	1835	1859	1879	1915	1985
190	1935	1959	1979	2015	2085
200	2035	2059	2079	2115	2185

ADJUSTABLE DOOR FRAMES

WITH ANGULAR ARCHITRAVE T80 OR T63

CONSTRUCTION

Adjustable door frame with angular architrave T80 or T63 is equipped with architrave elements with small rounding of the cross-section profile. It is made of a high-quality, wood-based MDF board. On its visual side it is entirely coated with a decorative, wood-imitation DRE-Cell veneer, 3D veneer, CPL laminate 0,15 - 0,2 mm, natural veneer (available only T80 architrave) or painted**. Its construction allows for use on walls with span 75-320 mm thick

**NOTE: To ensure the highest quality of painted door frames, before painting process they are coated with special material which constitutes solid base.



APPLICATION

Adjustable door frame can be applied for interior door leaf - rebated version and to glass doors (ORC).

SET CONTAINS

Main beam (one horizontal and two vertical elements together with masking elements), door gasket, set of hinges, all necessary components for the installation of door frames in accordance with the supplied instruction. Door frames are packed in cardboard boxes.

Door frames used as a set with frame construction doors and door frames with size "90" and wider, should be equipped with three hinges. Door frames for glass door "ORC" are equipped with two hinges ø 15 mm, special latch plate and rubber gasket.

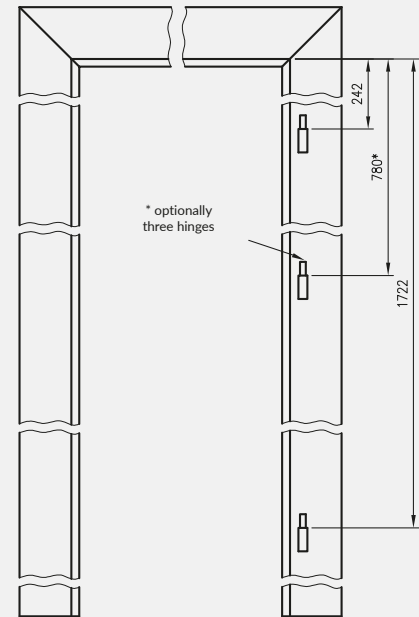

OR/ORC cross-section with T80 architrave

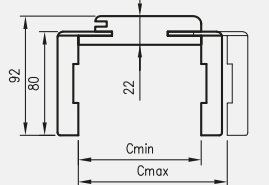

OR/ORC cross-section with T63 architrave

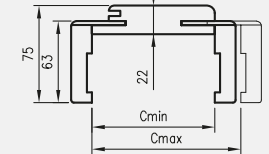

vertical cross-section of rebated door leaf with OR

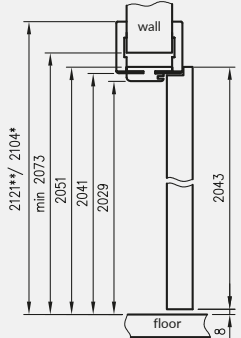

vertical cross-section of glass doors with ORC

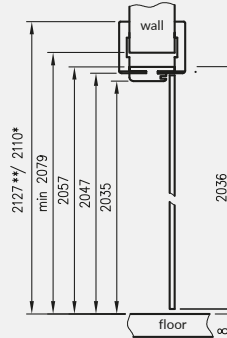

required wall passage height 2073 mm (2079 mm for glass doors)

OR/ORC horizontal cross-section

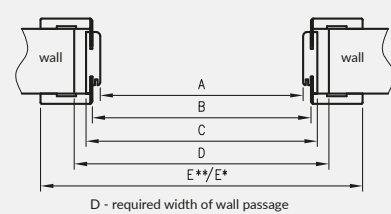

for single-leaf doors

	A	B	C	D	E**	E*
60	600	624	644	680	784	750
70	700	724	744	780	884	850
80	800	824	844	880	984	950
90	900	924	944	980	1084	1050
100	1000	1024	1044	1080	1184	1150
110	1100	1124	1144	1180	1284	1250

for double-leaf doors

	A	B	C	D	E**	E*
100d	1035	1059	1079	1115	1219	1185
110d	1135	1159	1179	1215	1319	1285
120	1235	1259	1279	1315	1419	1385
130	1335	1359	1379	1415	1519	1485
140	1435	1459	1479	1515	1619	1585
150	1535	1559	1579	1615	1719	1685
160	1635	1659	1679	1715	1819	1785
170	1735	1759	1779	1815	1919	1885
180	1835	1859	1879	1915	2019	1985
190	1935	1959	1979	2015	2119	2085
200	2035	2059	2079	2115	2219	2185

* dimension refer to door frame with T63 architrave

** dimension refer to door frame with T80 architrave

ADJUSTABLE DOOR FRAMES

WITH VARIABLE HEIGHTS AND ANGULAR ARCHITRAVE T80

By the fact of high interest, expressed by our clients, in doors with custom sizes, we have introduced to our sale offer collections MODERN, PLUS and STANDARD 10 door leaves, with adjustable door frame, equipped with angular architrave T80, in 3 additional heights.



APPLICATION

Adjustable door frame with variable heights, with T80 architrave, can be used with rebated door leaves STANDARD 10, MODERN and PLUS collections with three additional door leaves height options: 1983mm, 2110mm and 2240mm.

SET CONTAINS

Main beam (one horizontal and two vertical elements together with masking elements), door gasket, set of hinges, all necessary components for the installation of door frames in accordance with the supplied instruction. Door frames are packed in cardboard boxes.

All rebated door frames in 3 additional height options should be equipped with 3 hinges.

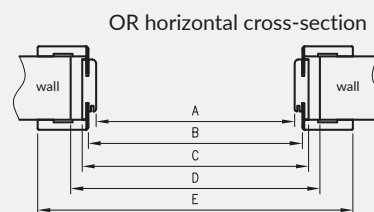
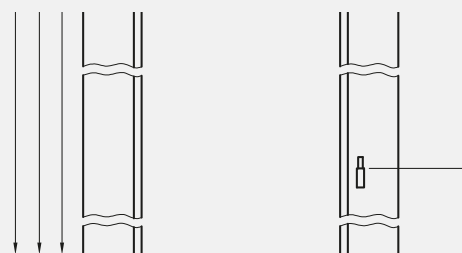
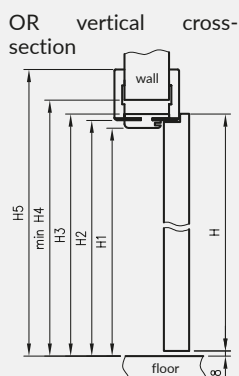
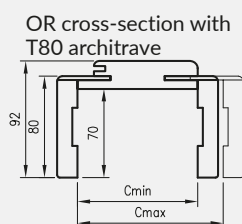

D - required width of wall passage

H	H1	H2	H3	H4	H5	Z3
1983	1969	1981	1991	2013	2061	1662
2110	2096	2108	2118	2140	2188	1789
2240	2226	2238	2248	2270	2318	1919

H - door leaf height
H4 - required wall passage height

for single-leaf doors

	A	B	C	D	E
60	600	624	644	680	784
70	700	724	744	780	884
80	800	824	844	880	984
90	900	924	944	980	1084
100	1000	1024	1044	1080	1184

for double-leaf doors

	A	B	C	D	E
120	1235	1259	1279	1315	1419
130	1335	1359	1379	1415	1519
140	1435	1459	1479	1515	1619
150	1535	1559	1579	1615	1719
160	1635	1659	1679	1715	1819
170	1735	1759	1779	1815	1919
180	1835	1859	1879	1915	2019
190	1935	1959	1979	2015	2119
200	2035	2059	2079	2115	2219

ADJUSTABLE DOOR FRAMES

NON-REBATED

CONSTRUCTION

Adjustable non-rebated door frame is made of a high-quality wood-based MDF board. On its visual side it is entirely coated with a decorative wood-imitation DRE-Cell veneer, 3D veneer, CPL laminate, natural veneer or painted**. Its construction allows to be used with door leaf with the thickness of 40 mm and its design allows to be used on walls with span 75-320. In white mat colour there is possibility to choose connection of main beams at 90 degree.

**NOTE: To ensure the highest quality of painted door frames, before painting process they are coated with special material which constitutes solid base.

APPLICATION

Adjustable non-rebated door frame can be used with all DRE non-rebated collections of the door leaf.

SET CONTAINS

Main beam (one horizontal and two vertical elements) with wide angular architrave (80 mm) with small rounding angles of the cross-section profile (R2), door gasket, a set of hinges, all necessary components for the installation of door frames in accordance with the supplied instruction. Door frames are packed in cardboard boxes.

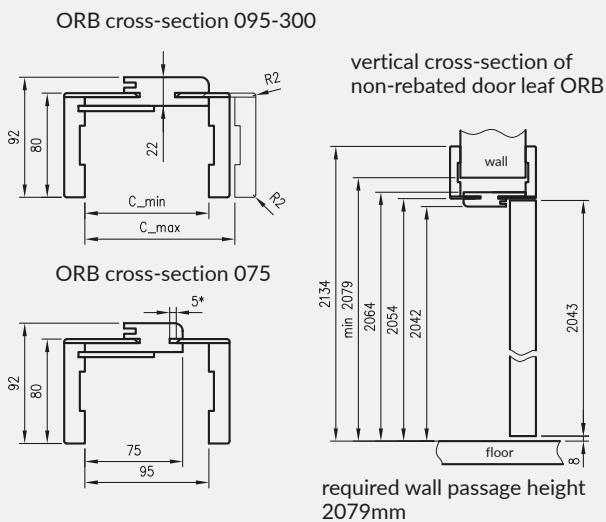

*075-095 door frame has a different cross section, for a 75-89 mm wall thickness, it will be necessary to shorten pen of the adjustable angle element.

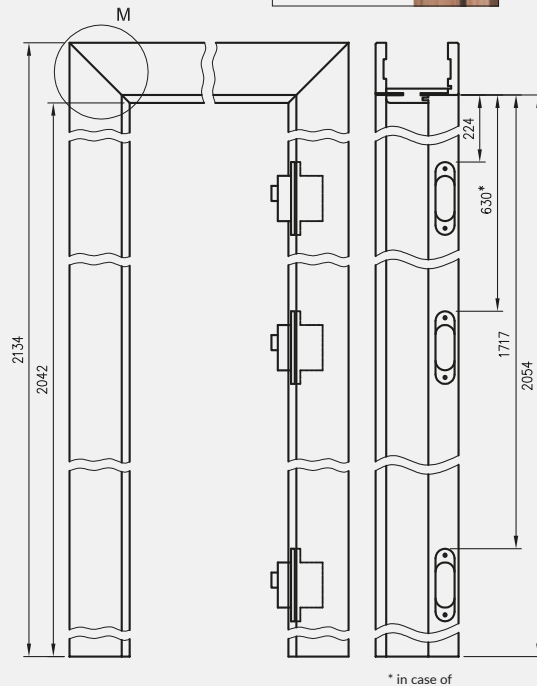

* in case of

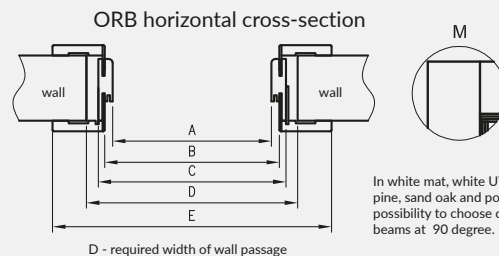

In white mat, white UV varnish, white pine, sand oak and polish oak 3D there is possibility to choose connection of main beams at 90 degree.

for single-leaf doors

	A	B	C	D	E
60	627	651	671	711	811
70	727	751	771	811	911
80	827	851	871	911	1011
90	927	951	971	1011	1111
100	1027	1051	1071	1111	1211

for double-leaf doors

	A	B	C	D	E
120	1274	1298	1318	1378	1458
130	1374	1398	1418	1478	1558
140	1474	1498	1518	1578	1658
150	1574	1598	1618	1678	1758
160	1674	1698	1718	1778	1858
170	1774	1798	1818	1878	1958
180	1874	1898	1918	1978	2058

ADJUSTABLE DOOR FRAMES

NON-REBATED WITH VARIABLE HEIGHTS

By the fact of high interest expressed by our clients in non-rebated doors with custom sizes, we have introduced to our sale offer collections MODERN, PLUS and STANDARD 10 door leaves with non-rebated adjustable door frame in 3 additional heights. Construction of the door frame is the same as in the non-rebated adjustable door frame (they vary only in height).

APPLICATION

Non-rebated adjustable door frame with variable heights can be used with non-rebated STANDARD 10, MODERN and PLUS door leaves which are available in three additional door leaves height options: 1983 mm, 2110 mm and 2240 mm.

SET CONTAINS

Main beam (one horizontal and two vertical elements together with masking elements), door gasket, set of hinges, all necessary components for the installation of door frames in accordance with the supplied instruction. Door frames are packed in cardboard boxes.

All door frames in 3 additional height options can be equipped with 2 or 3 hinges.

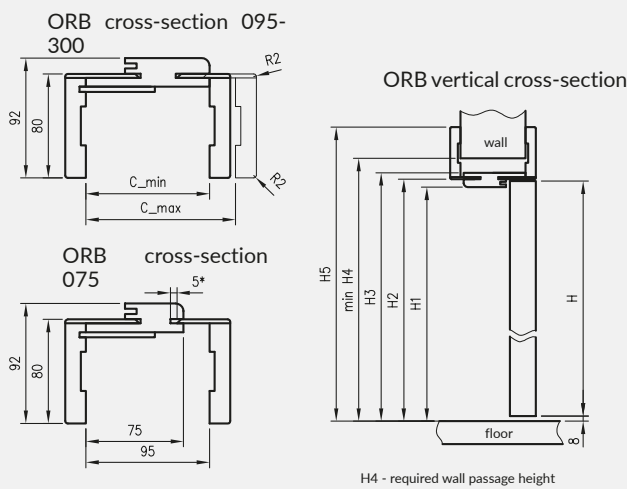

H4 - required wall passage height

*NOTE: 075-095 door frame has a different cross-section, for a 75-89 mm wall thickness, it will be necessary to shorten pen of the adjustable angle element.

H - door leaf height	H1	H2	H3	H4	H5	Z2	Z3
1983	1982	1994	2004	2019	2074	610	1657
2110	2109	2121	2131	2146	2201	651	1784
2240	2239	2251	2261	2276	2331	695	1914

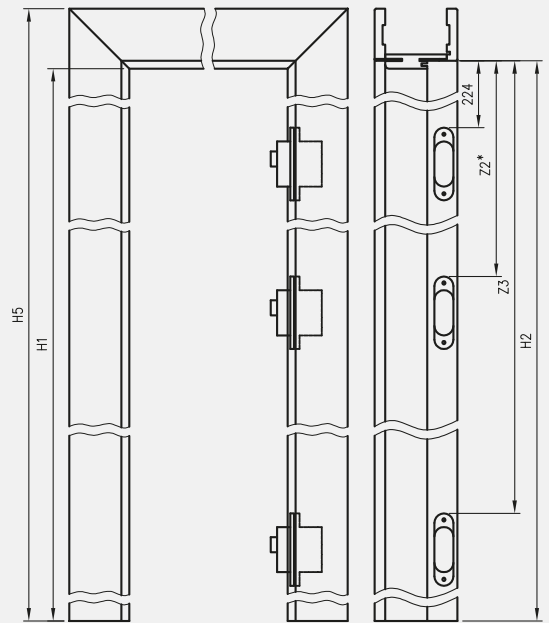

* optionally

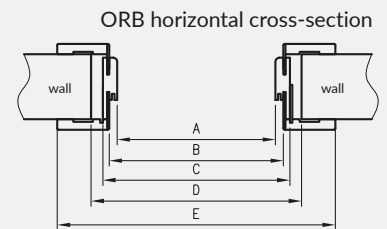

D - required width of wall passage

for single-leaf doors

	A	B	C	D	E
60	627	651	671	711	811
70	727	751	771	811	911
80	827	851	871	911	1011
90	927	951	971	1011	1111
100	1027	1051	1071	1111	1211

for double-leaf doors

	A	B	C	D	E
120	1274	1298	1318	1378	1458
130	1374	1398	1418	1478	1558
140	1474	1498	1518	1578	1658
150	1574	1598	1618	1678	1758
160	1674	1698	1718	1778	1858
170	1774	1798	1818	1878	1958
180	1874	1898	1918	1978	2058

ADJUSTABLE DOOR FRAMES

DOOR LEAVES WITH INVERTED REBATE



UNI 10 non-rebated door leaf (on the left) and inverted rebate (on the right) - white

Decor



white acrylic UV varnish - RAL 9003
ecru - RAL 9001
latte - Flugger 4362, NCS S1505-Y50R
ashen - RAL 7035



TECTUS 240 3D hinge

ADJUSTABLE DOOR FRAMES

DOOR LEAVES WITH INVERTED REBATE

DOOR FRAME CONSTRUCTION

Adjustable door frame with inverted rebate is made of a high-quality wood-based MDF board. On its visual side it is painted with highest quality acrylic UV varnish. To ensure the highest quality of painted door frames, before painting process, they are coated with special material which constitutes solid base. Its construction allows to be used with door leaves with the thickness of 40 mm and its design allows to be used on walls with span 90-290 mm.

APPLICATION

Door frame can be applied to door leaves with inverted rebate, from collection: Uni, Binito, Fargo.

SET CONTAINS

Main beam (one horizontal and two vertical elements) with wide angular architrave T80, door gasket, set of two TECTUS 240 3D hinges, all necessary components for the installation of door frames in accordance with the supplied instruction. Door frames are packed in cardboard boxes.



door frame profile

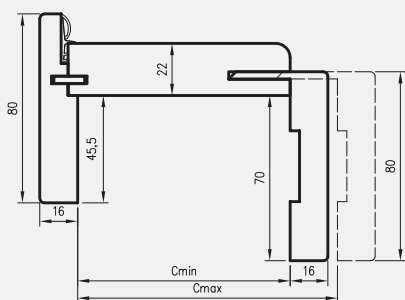

vertical cross-section of ORO

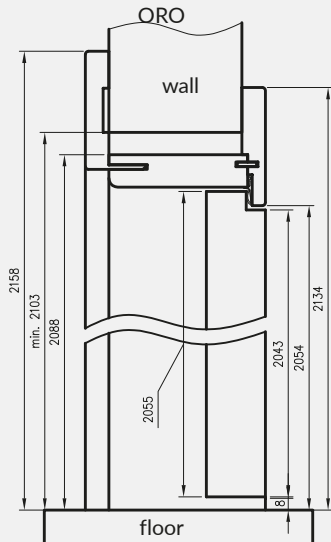

Required height of the wall opening = 2103 mm

	A	B	C	D	E	F	S	S2
60	625	650	694	724	785	834	644	619
70	725	750	794	824	885	934	744	719
80	825	850	894	924	985	1034	844	819
90	925	950	994	1024	1085	1134	944	919
100	1025	1050	1094	1124	1185	1234	1044	1019

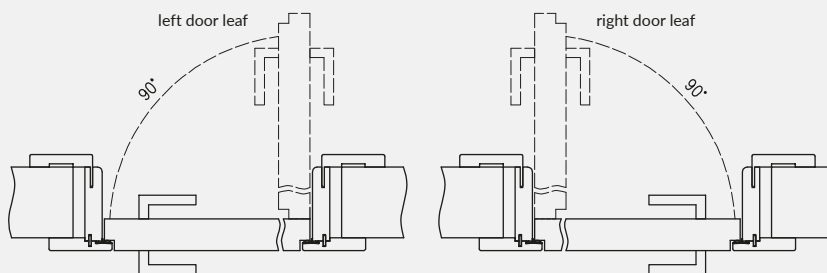

horizontal cross-section of ORO

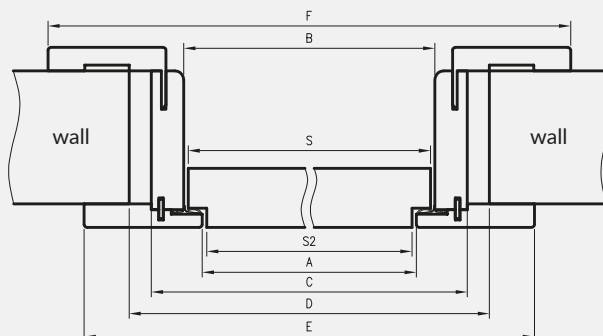

D - required width of wall passage

ADJUSTABLE TUNNEL

WITH K63, N63, T63, T80 ANGULAR ARCHITRAVE

Adjustable tunnel is a decorative cover of wall passage. It can be used as a separate solution or as an integral part of the sliding wall-mounted system NT.

The adjustable tunnel is a product which, at first glance is visually similar to adjustable door frames, but with a few differences:

- » there is no possibility to mount any hinges
- » there is no latch strike plate
- » there is no channel for a gasket, different heights and spans of the front and rear architraves (values E and F in tables)



TUN cross-section with K63

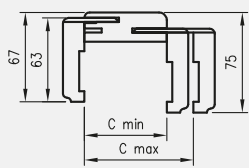

NOTE: To ensure the highest quality of painted tunnels, before painting process they are coated with special material which constitutes solid base.



TUN Natura cross-section with N63

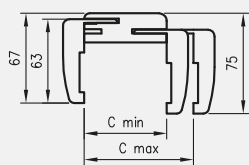

TUN cross-section with T80

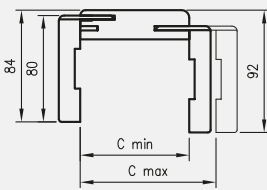

TUN cross-section with T63

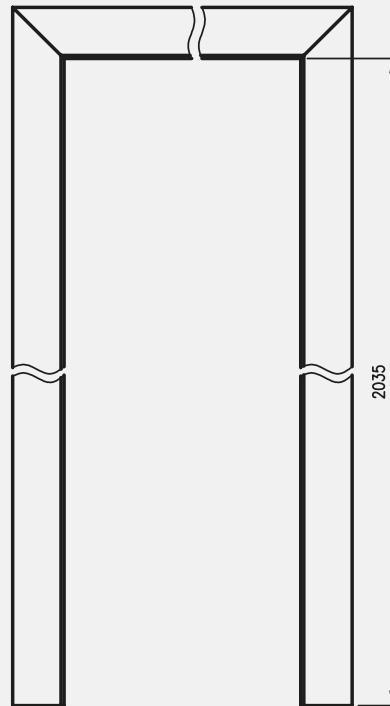
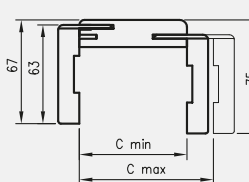

vertical cross-section of adjustable tunnel with K63, N63 or T63

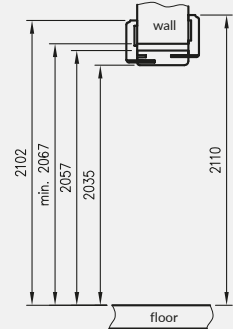

vertical cross-section of adjustable tunnel with T80

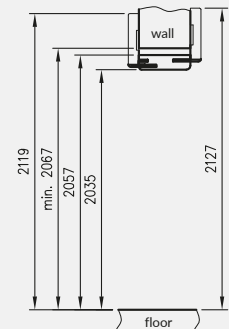

required height of wall opening 2067 mm

Single adjustable tunnel

symbol	60	70	80	90	100
A	600	700	800	900	1000
C	644	744	844	944	1044
D	664	764	864	964	1064
E	750	850	950	1050	1150
E*	784	884	984	1084	1184
F	734	834	934	1034	1134
F*	768	868	968	1068	1168

Double adjustable tunnel

symbol	120	140	160	180	200
A	1200	1400	1600	1800	2000
C	1244	1444	1644	1844	2044
D	1264	1464	1664	1864	2064
E	1350	1550	1750	1950	2150
E*	1384	1584	1784	1984	2184
F	1334	1534	1734	1934	2134
F*	1368	1568	1768	1968	2168

cross section of adjustable tunnel E / E*

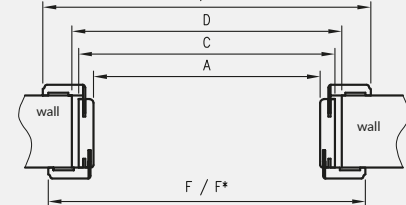

D - required width of wall passage
*refers to Adjustable Tunnel with T80



STANDARD 10 with adjustable tunnel CPL laminate dark gray

EXTENSION PANELS

APPLICATION

Extension panel it is a component of decorative cover of wall passage but also it can be used as extension to install door frames in walls, which are thicker than 320mm. Panel is an extension of middle parts of adjustable door frames and adjustable tunnels. It might be used together with architraves from previous orders of door frames and adjustable tunnels with connection of main beams at 45 degree. Extension panels with variable heights are available only in Cell and CPL group.

SET CONTAINS

- » two vertical beams
- » horizontal beam
- » three connecting pens
- » accessories used to connect main beams

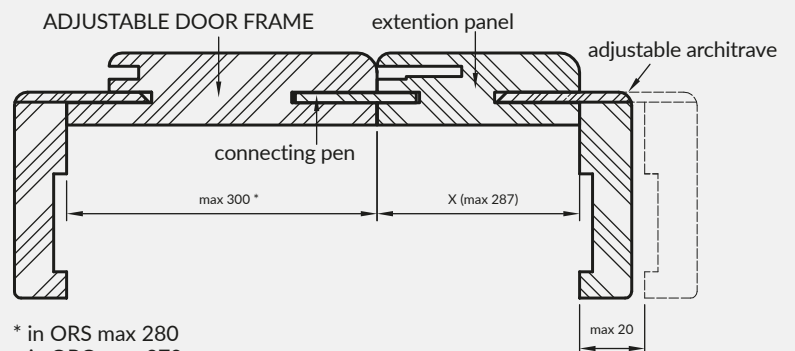
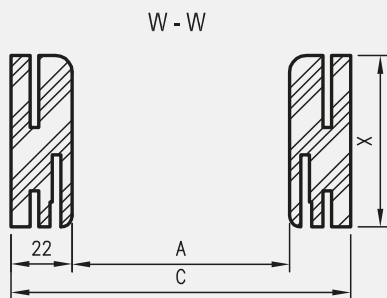
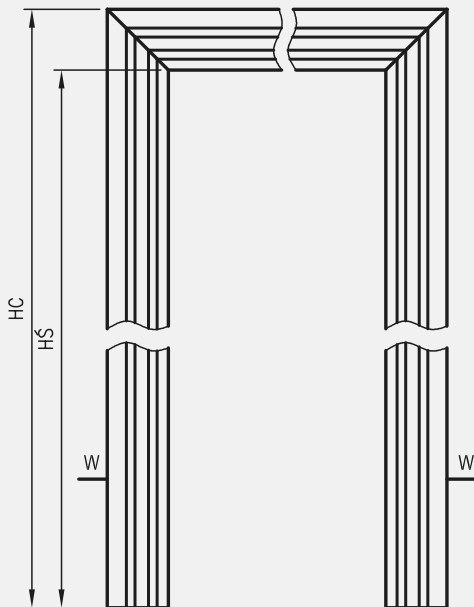

* in ORS max 280
in ORO max 270
in TUN max 287

options of the width of panels cross-section

X	062	082	107	127	147	167	187	207	227	247	267	287
---	-----	-----	-----	-----	-----	-----	-----	-----	-----	-----	-----	-----

EXTENSION PANELS

Dimensions of extension panels OR - adjustable door frames for rebated doors

height options					for single-leaf doors						for double-leaf doors											
	PL	198x	211x	224X	„60”	„70”	„80”	„90”	„100”	„110”	„100d”	„110d”	„120”	„130”	„140”	„150”	„160”	„170”	„180”	„190”	„200”	
HŚ	2029	1969	2096	2226	A	600	700	800	900	1000	1100	1035	1135	1235	1335	1435	1535	1635	1735	1835	1935	2035
HC	2051	1991	2118	2248	C	644	744	844	944	1044	1144	1079	1179	1279	1379	1479	1579	1679	1779	1879	1979	2079

Dimensions of the ORB extension panels - non-rebated adjustable door frames connected at 45 degree

height options					for single-leaf doors					for double-leaf doors							
	PL	198x	211x	224X	„60”	„70”	„80”	„90”	„100”	„120”	„130”	„140”	„150”	„160”	„170”	„180”	
HŚ	2042	1982	2109	2239	A	627	727	827	927	1027	1274	1374	1474	1574	1674	1774	1874
HC	2064	2004	2131	2261	C	671	771	871	971	1071	1318	1418	1518	1618	1718	1818	1918

Dimensions of TUN extension panels - adjustable tunnels

		for single-leaf doors					for double-leaf doors					
	PL	„60”	„70”	„80”	„90”	„100”	„120”	„140”	„160”	„180”	„200”	
HŚ	2035	A	600	700	800	900	1000	1200	1400	1600	1800	2000
HC	2057	C	644	744	844	944	1044	1244	1444	1644	1844	2044

Dimensions of the ORC extension panels - adjustable door frames for glass doors

		„60”	„70”	„80”	„90”	
HŚ	2035	A	600	700	800	900
HC	2057	C	644	744	844	944

Dimensions of the ORS extension panels - adjustable door frames for folding doors

		„80”	„90”	„100”	
HŚ	2029	A	806	906	1006
HC	2051	C	850	950	1050

Dimensions of ORO extension panels - adjustable door frames for door leaves with inverted rebate

		„60”	„70”	„80”	„90”	„100”	
HŚ	2066	A	650	750	850	950	1050
HC	2088	C	694	794	894	994	1094

HYBRID STEEL DOOR FRAME

FOR ENTER, SOLID, SOLID RC2 DOOR LEAVES



brown mat + honey oak CPL

dark gray mat + dark gray CPL

* exemplary colour configurations of steel door frame with panel

								
white mat	light gray mat	dark gray matt	brown mat	white semi-gloss	light gray semi-gloss	dark grey semi-gloss	brown semi-gloss	beige semi-gloss***
RAL 9003	RAL 7047	RAL 7024	RAL 8017	RAL 9003	RAL 7047	RAL 7024	RAL 8017	RAL 1001

Colors in two gloss scale (matte / low structure, semi-gloss / plain).

*** beige colour is available only in semi-gloss

HYBRID STEEL DOOR FRAME

FOR ENTER, SOLID, SOLID RC2 DOOR LEAVES

Hybrid steel door frame - it is an innovative solution in our sale offer, which combine solidity of metal construction with additional functionality it allows to fully finish wall passage by using door frame elements made of MDF, coated with CPL laminate.

Hybrid steel door frame it is combination of metal door frame with fixed width, MDF panel available in 11 options of width and masking architraves. This solution allows to finish walls with span between 137-357 mm, and additional possible adjustment up to 20 mm.

APPLICATION:

Hybrid door frame is intended to be used with entrance doors Solid, Enter and SOLID RC2 models (it is equipped with 4 holes for latch bolts and multi point latch lock used in SOLID model) it can be successfully used as a complementary product with interior rebated doors - with notification that, MDF panel part is available only in CPL laminates. Assembly of the door frame is to be done on ready floor level.

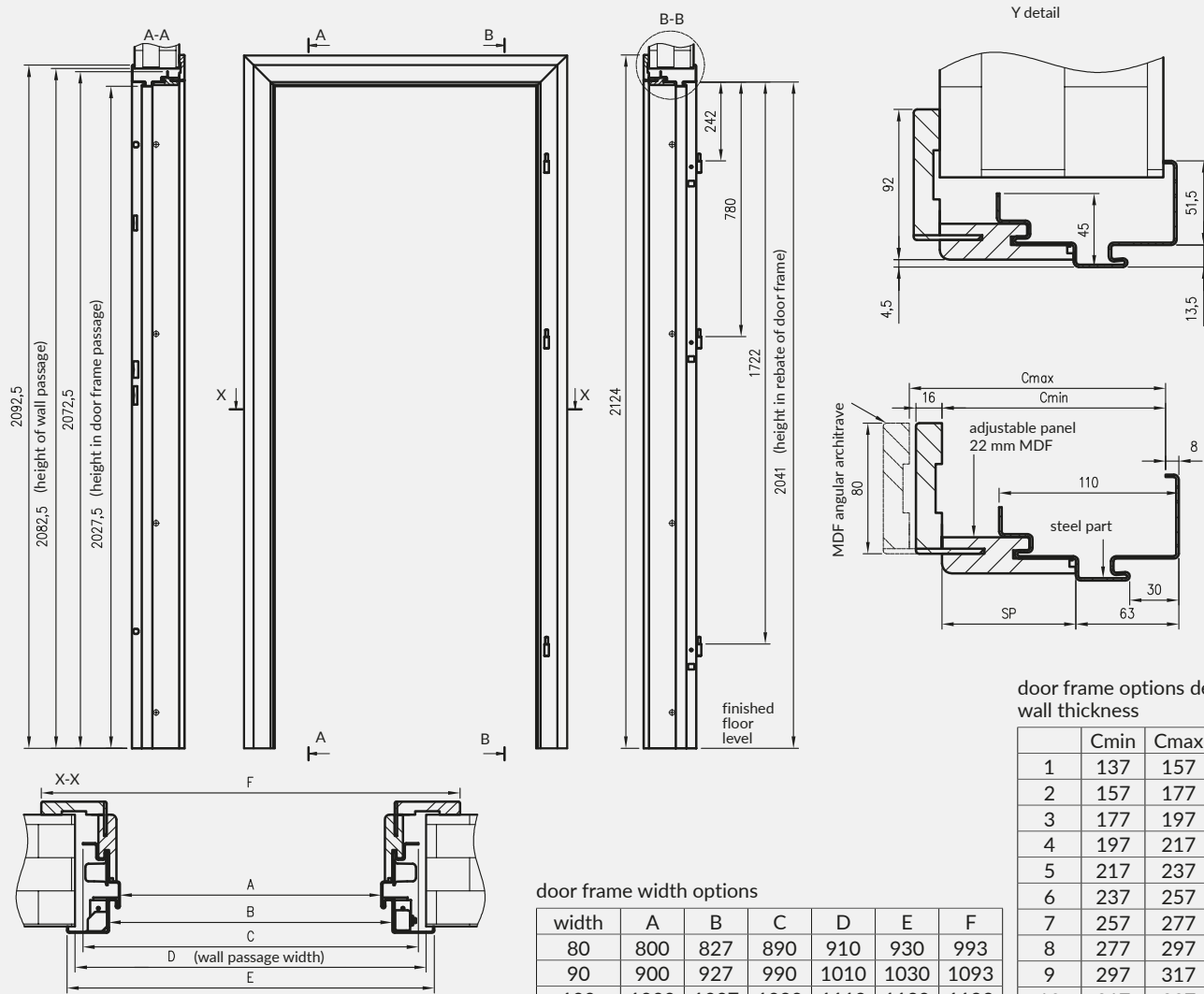

door frame options depending on wall thickness

	Cmin	Cmax	SP
1	137	157	82
2	157	177	102
3	177	197	122
4	197	217	142
5	217	237	162
6	237	257	182
7	257	277	202
8	277	297	222
9	297	317	242
10	317	337	262
11	337	357	282

door frame width options

width	A	B	C	D	E	F
80	800	827	890	910	930	993
90	900	927	990	1010	1030	1093
100	1000	1027	1090	1110	1130	1193

ADJUSTABLE METAL DOOR FRAME

FOR ENTER, SOLID DOOR LEAVES

DOOR FRAME CONSTRUCTION

Adjustable steel frame is made of low-carbon steel sheet with a thickness 1.5 mm. Vertical element and lintel are permanently welded together. Door frame is powder coated and available in colours from RAL pallet: 9003-white, 8017-brown, 1001-beige, 7047-light gray, 7024-dark gray in two gloss scale (mat / low structure, semi-gloss / plain). Both external side and internal side of door frame are secured with lacquered, organic protective surface. On its one side there are made 4 holes for latch bolt and bolts installed in entrance DRE doors, on the opposite side there are 3 sockets for hinges and anti-thrust bolts.

APPLICATION

Metal door frames can be applied to interior entrance doors ENTER and SOLID.

STANDARD OPTIONS

- » sockets for 3 hinges
- » additional sockets for anti-thrust bolts
- » sockets for latch bolts of multi-point lock used in SOLID model

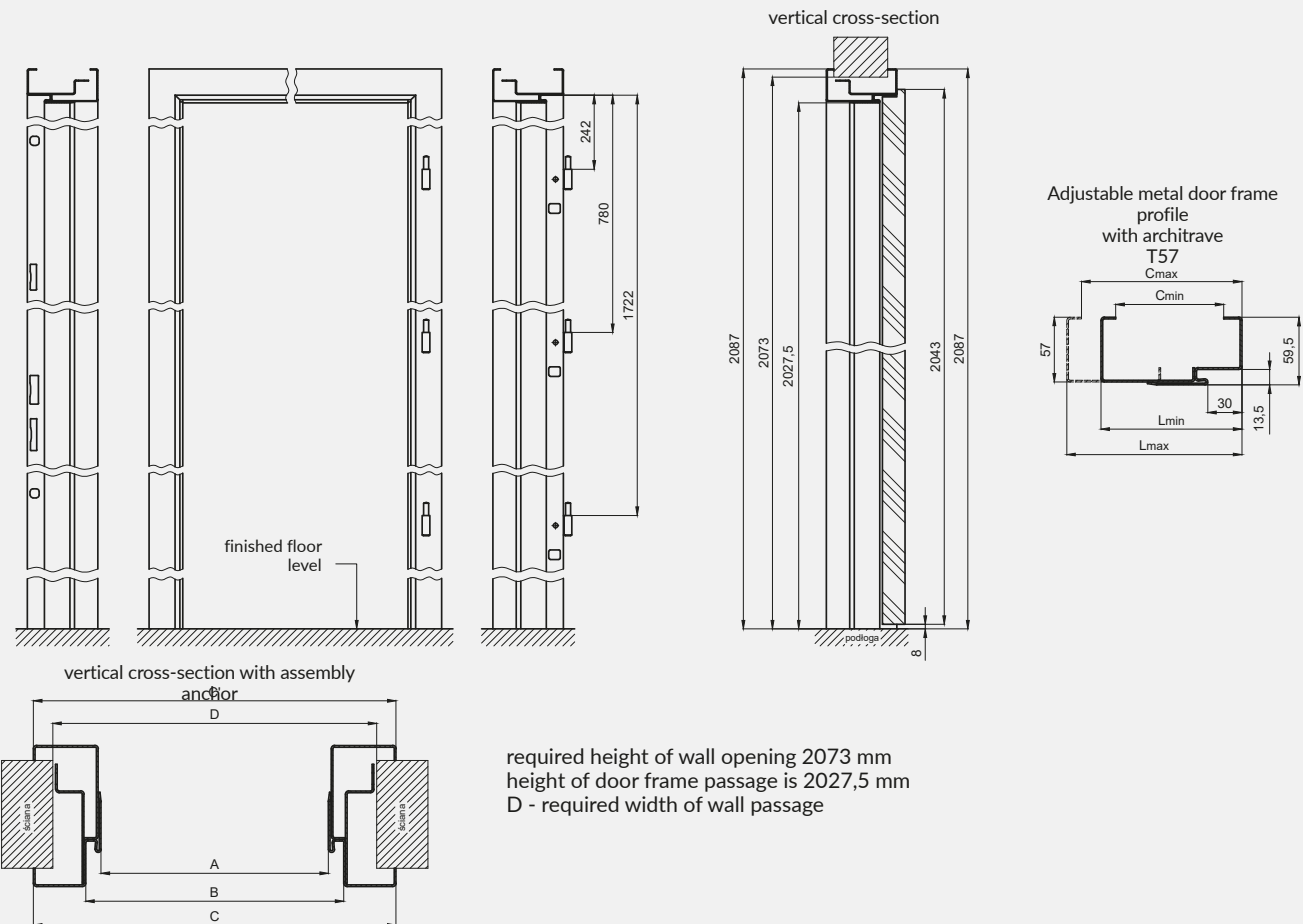

	A	B	C, C'	D
„80”	800	827	919	890
„90”	900	927	1019	990
„100”	1000	1027	1119	1090

wall thickness		width of the door frame profile	
Cmin	Cmax	Lmin	Lmax
95	125	124	154
125	155	154	184
155	185	184	214
185	215	214	244
215	245	244	274
245	275	274	304
275	305	304	334

METAL FIXED DOOR FRAME

FOR ENTER, SOLID DOOR LEAVES

CONSTRUCTION

Metal welded door frame is made of steel low carbon sheet 1,5 mm thick. Door frame is powder coated and available in colours from RAL pallet: 1001 - beige semi gloss, 9003-white, 8017-brown, 7047-light gray, 7024-dark gray in two gloss scale (mat low structure/semi gloss). Both external side and internal side of door frame are secured with lacquered organic protective surface. On its one side there are made 4 holes for latch bolt and bolts installed in entrance DRE doors, and on the opposite side there are 3 sockets for hinges and anti-thrust bolts.

APPLICATION

Metal door frames can be applied to interior entrance doors ENTER and SOLID. It is intended to be installed on finished floor level.

STANDARD OPTIONS

- » sockets for 3 hinges
- » additional sockets for anti-thrust bolts
- » sockets for latch bolts of multi-point lock used in SOLID model



Metal door frame profile

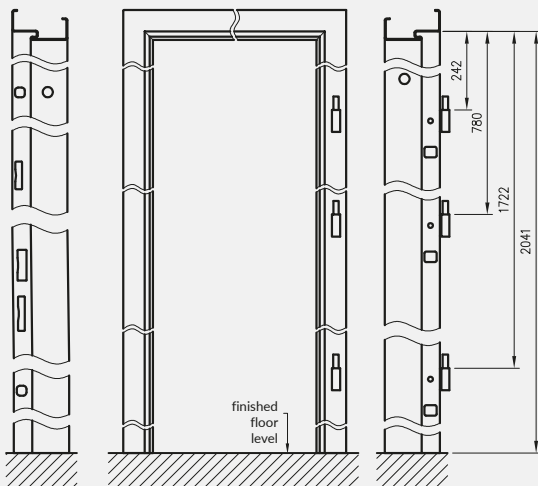
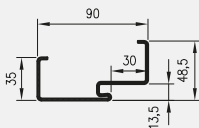

vertical cross-section

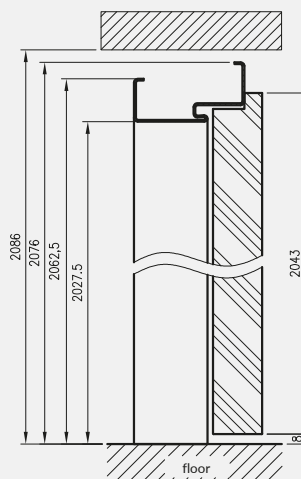

vertical cross-section optional assembly method

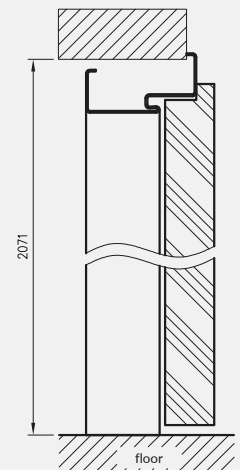

cross-section

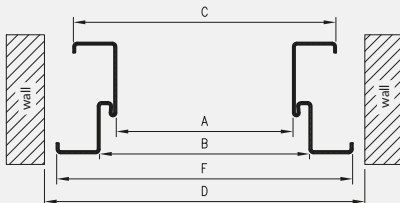

cross-section optional assembly method

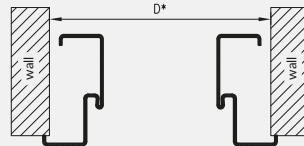

** required height of wall passage measured from the level of finished floor is 2086 mm or 2071* mm in optional assembly method

height of door frame passage is 2027,5 mm

D, D*- required width of wall passage
* optional assembly method

	A	B	C	D	D*	F
„80”	800	827	870	917	887	897
„90”	900	927	970	1017	987	997
„100”	1000	1027	1070	1117	1087	1097



Colors in two gloss scale (matte / low structure, semi-gloss / plain).

*** beige colour is available only in semi-gloss



handle MEDA - shiny chrome inserts in DRE-Cell, 3D and CPL colours



backplate for simple key



backplate for cylinder lock



backplate for toilet lock

SELECTED COLOURS OF INSERTS



white insert



walnut insert



sand oak insert



golden oak insert



siberian oak insert



tabac elm insert



anthracite elm insert



vintage oak insert



american walnut insert



dark wenge insert



elm insert



polish oak 3D insert



grand oak insert



gray oak CPL insert



welsh oak CPL insert



walnut CPL insert



celini walnut CPL insert



concrete 1 CPL insert

DOOR HANDLES



TOTAL door handle - shiny chrome



door handle TOTAL - matt brushed nickel

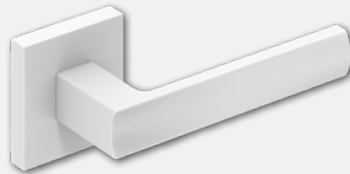

door handle IBIZA - white matt

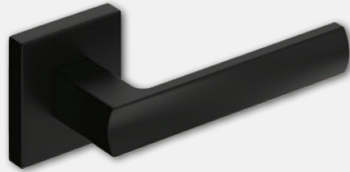

door handle IBIZA - black matt

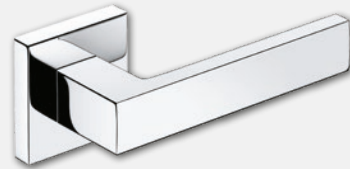

door handle CUBE - shiny chrome

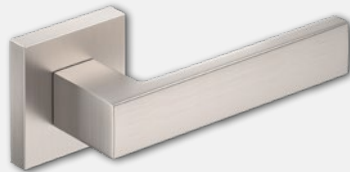

door handle CUBE - brushed nickel

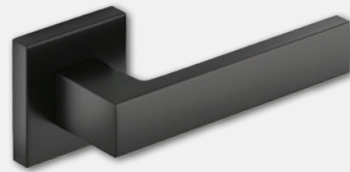

door handle CUBE - black matt



backplate for simple key



backplate for cylinder lock



backplate for toilet lock



backplate for simple key



backplate for cylinder lock



backplate for toilet lock



backplate for simple key



backplate for cylinder lock



backplate for toilet lock



backplate for simple key



backplate for cylinder lock



backplate for toilet lock



backplate for simple key



backplate for cylinder lock



backplate for toilet lock



backplate for simple key



backplate for cylinder lock



backplate for toilet lock



backplate for simple key



backplate for cylinder lock



backplate for toilet lock

DOOR HANDLES



door handle MONDO - nickel satin



backplate for simple key



backplate for cylinder lock



backplate for toilet lock



door handle TREND - satin nickel



backplate for simple key



backplate for cylinder lock



backplate for toilet lock



door handle PRIMA - nickel satin



backplate for simple key



backplate for cylinder lock



backplate for toilet lock



door handle LINEA - shiny chrome



backplate for simple key



backplate for cylinder lock



backplate for toilet lock



door handle LINEA - nickel satin



backplate for simple key



backplate for cylinder lock



backplate for toilet lock



door handle VENUS - black matt



backplate for simple key



backplate for cylinder lock



backplate for toilet lock



door handle ZORBA - shiny chrome/satin



backplate for simple key



backplate for cylinder lock



backplate for toilet lock

DOOR HANDLES



door handle FEBE - brushed nickel



backplate for simple key lock



backplate for cylinder lock



backplate for toilet lock



door handle JOWISZ - stainless steel



backplate for simple key



backplate for cylinder lock



backplate for toilet lock



door handle NOVA - stainless steel



backplate for simple key



backplate for cylinder lock



backplate for toilet lock



door handle PROXIMA - stainless steel



backplate for simple key



backplate for cylinder lock



backplate for toilet lock



door handle TOPAZ - stainless steel



backplate for simple key



backplate for cylinder lock



backplate for toilet lock

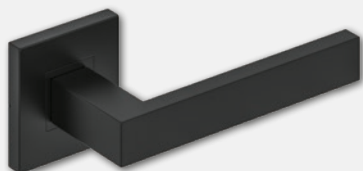

door handle TOPAZ - stainless steel, black matt



backplate for simple key



backplate for cylinder lock



backplate for toilet lock



door handle ONYX M - stainless steel



backplate for simple key



backplate for cylinder lock



backplate for toilet lock

DOOR HANDLES



door handle LUNA - brushed chrome



backplate for simple key



backplate for cylinder lock



backplate for toilet lock



door handle LUNA - glossy brass



backplate for simple key



backplate for cylinder lock



backplate for toilet lock



door handle IBIZA - graphite / chrome



backplate for simple key



backplate for cylinder lock



backplate for toilet lock



handle IBIZA - satin nickel



backplate for simple key



backplate for cylinder lock



backplate for toilet lock

NEW



IBIZA door handle shiny chrome



backplate for simple key



backplate for cylinder lock



backplate for toilet lock



door handle BETA - satin nickel



backplate for simple key



backplate for cylinder lock



backplate for toilet lock



door handle EUROPA - satin nickel



backplate for simple key



backplate for cylinder lock



backplate for toilet lock

DOOR HANDLES

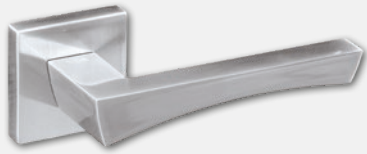

door handle ONYX - nickel / satin



backplate for simple key



backplate for cylinder lock



backplate for toilet lock



door handle QUANTA - nickel - satin



backplate for simple key



backplate for cylinder lock



backplate for toilet lock



door handle WARNA - nickel satin



backplate for simple key



backplate for cylinder lock



backplate for toilet lock



door handle FENIKS - chrome mat



backplate for simple key



backplate for cylinder lock



backplate for toilet lock



door handle PEM - matt chrome



backplate for simple key



backplate for cylinder lock



backplate for toilet lock



door handle TOM - matt chrome



backplate for simple key



backplate for cylinder lock



backplate for toilet lock



door handle APUS - matt nickel



backplate for simple key



backplate for cylinder lock



backplate for toilet lock

DOOR HANDLES



door handle FOKUS - velvet nickel satin



backplate for simple key



backplate for cylinder lock



backplate for toilet lock

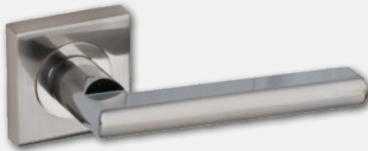

door handle JANE - painted nickel



backplate for simple key



backplate for cylinder lock



backplate for toilet lock



door handle UNO - stainless steel



backplate for simple key



backplate for cylinder lock



backplate for toilet lock



door handle ROMANA - chrome / lacquered nickel



backplate for simple key



backplate for cylinder lock



backplate for toilet lock



door handle MINIMAL - painted nickel



backplate for simple key



backplate for cylinder lock



backplate for toilet lock



door handle QUBIK - lacquered nickel



backplate for simple key



backplate for cylinder lock



backplate for toilet lock



door handle LIBRA - satin nickel



backplate for simple key



backplate for cylinder lock



backplate for toilet lock

DOOR HANDLES

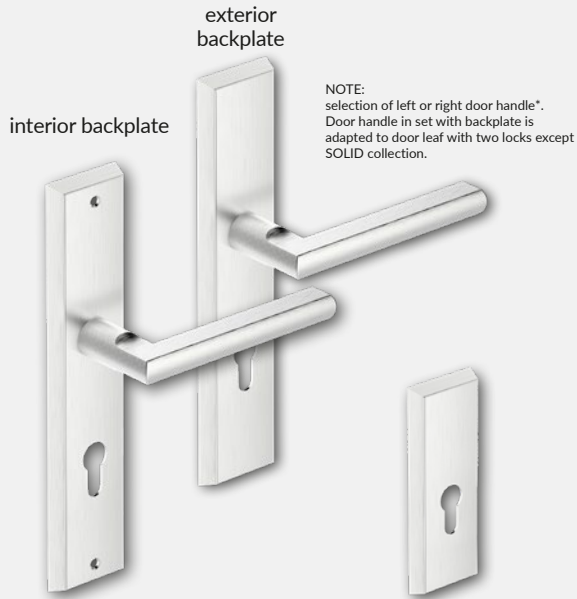

handle METRO (span 72 mm) stainless steel for cylinder lock



exterior TOTAL door handle with oblong backplate (span 72 mm) inox plus

short upper backplate TOTAL short inox plus

*left door handle

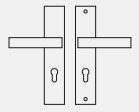

* right door handle

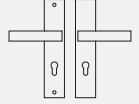

ZORBA door handle with oblong backplate - shiny chrome / satin



door handle ZORBA with oblong backplate for simple key - shiny chrome / satin (72 mm span)



ZORBA door handle with oblong backplate for cylinder lock - shiny chrome / satin (span 72 mm)



ZORBA door handle with oblong backplate - shiny chrome / satin (span 72 mm)



PEGAZ door handle (span 72 mm) Nickel mat for cylinder lock



TOM door handle with oblong backplate for cylinder lock (span 72 mm) matt chrome



technical handle STAR TEC - class IV - stainless steel matt price for a set (handle + backplate for cylinder lock)



backplate for cylinder lock

VENEER COLOURS



white (wood grain structure)	white mat	white pine	siberian elm	silver	sand oak
bleached oak textured	vintage oak	ash	beech	alder	calvados
golden oak	golden oak textured	walnut	dark walnut textured	caramel walnut	tabac elm
anthracite elm	gray oak textured***	dark wenge	gray textured	black textured	toffee oak ***



noble white VV F7206 CPL 0,15 mm thick CPL 0,8 mm thick	gray oak CPL 0,2 mm thick CPL 0,7 mm thick	welsh oak CPL 0,2 mm thick CPL 0,7 mm thick	walnut CPL 0,2 mm thick CPL 0,7 mm thick	celini walnut CPL 0,2 mm thick CPL 0,7 mm thick	concrete 1 - F6462 CPL 0,15 mm thick CPL 0,8 mm thick
concrete 2 CPL 0,2 mm thick CPL 0,7 mm thick	acacia CPL 0,2 mm thick CPL 0,7 mm thick	honey oak CPL 0,2 mm thick CPL 0,7 mm thick	chestnut CPL 0,2 mm thick CPL 0,7 mm thick	roasted walnut CPL 0,2 mm thick CPL 0,7 mm thick	
white W0118 CPL 0,15 mm thick CPL 0,7 mm thick	light gray CPL 0,15 mm thick CPL 0,8 mm thick RAL = 7047	dark grey CPL 0,2 mm thick CPL 0,7 mm thick			

*** decor available only in horizontal wood grain.

VENEER COLOURS

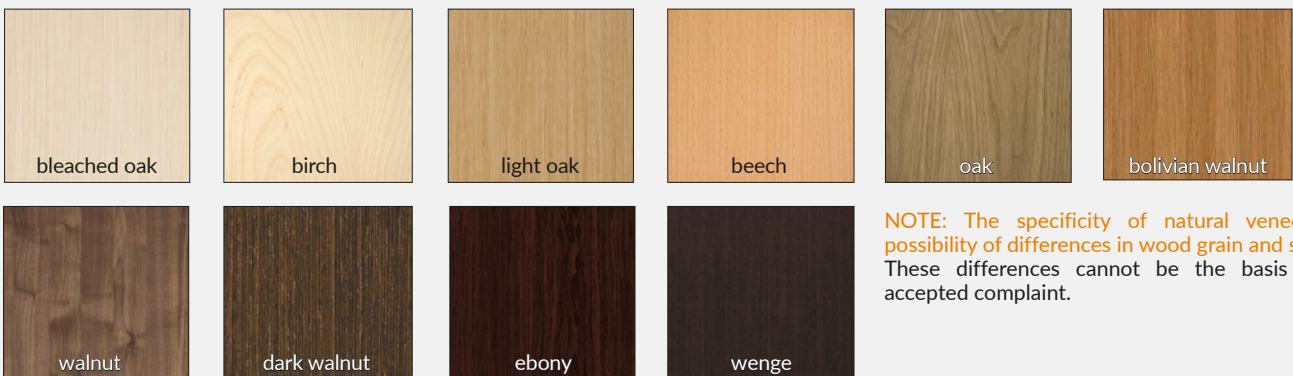
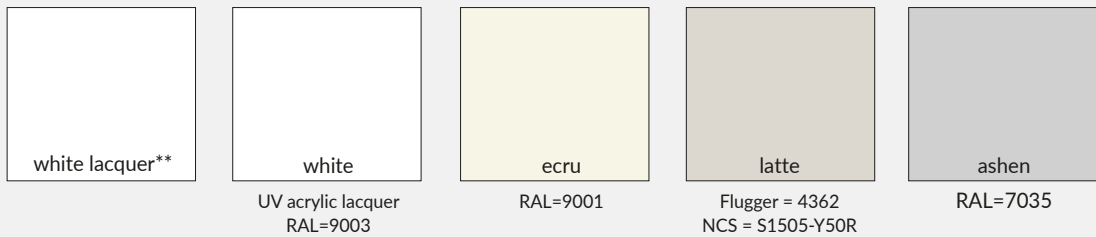

NOTE: The specificity of natural veneer is a possibility of differences in wood grain and staining. These differences cannot be the basis of the accepted complaint.

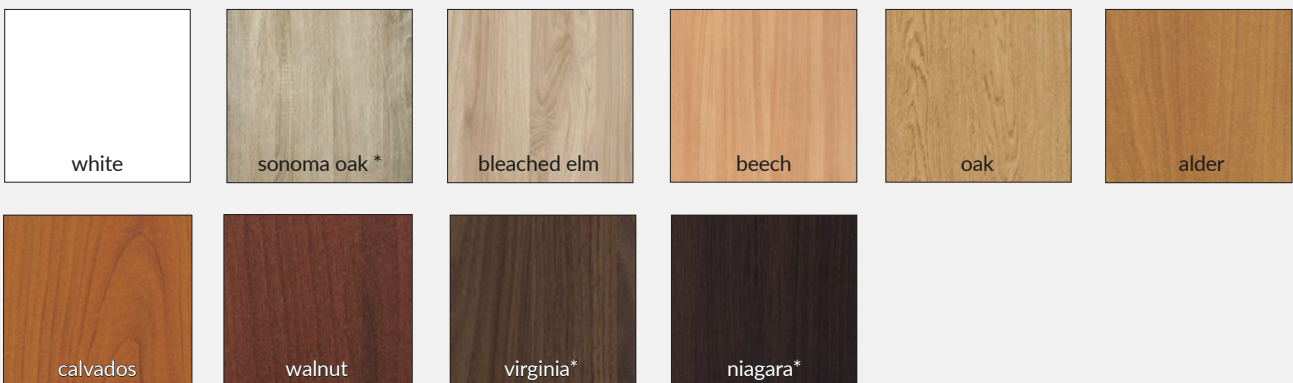

NOTE: Due to different manufacturing technology:

- » LACK and ASCADA door leaf collection - lacquered HDF board
- » door frames, architraves, Finish quarter rounds, glazing bars -coated with Finish decor
- » door leaf edges - edge banding

There are colour differences between those elements.

* available only in frame construction door leaf SINCO

* available only in panel construction door leaf DUO

GLASS PANE PATTERNS

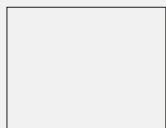

pattern 1 VETRO
transparent

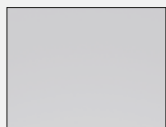

pattern 1 VETRO
decormat

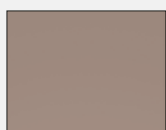

pattern 1 VETRO
decormat brown

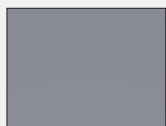

pattern 1 VETRO
decormat graphite



VETRO pattern E
black opaque laminated
glass

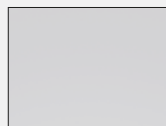

VETRO pattern E
laminated glass
decormat



pattern 2 VETRO

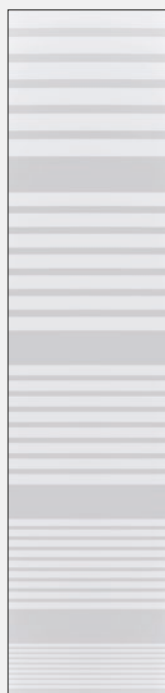

pattern 3 VETRO

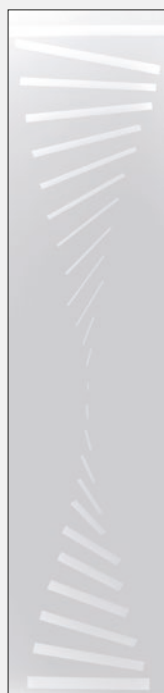

pattern 4 VETRO

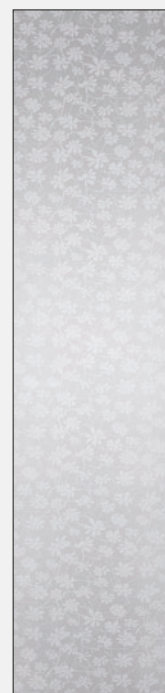

pattern 5 VETRO

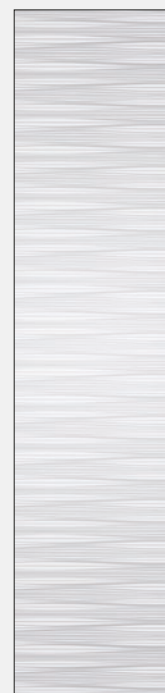

pattern 10 VETRO



pattern 11 VETRO

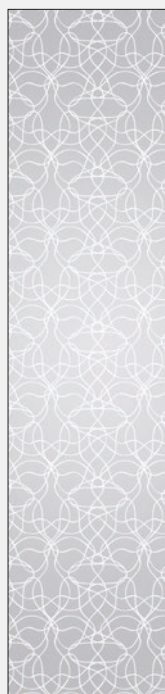

pattern 12 VETRO

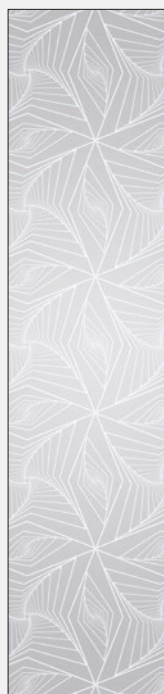

pattern 13 VETRO



pattern 14 VETRO

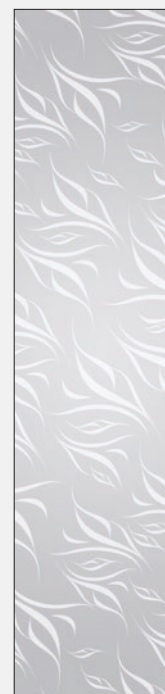

pattern 15 VETRO

GLASS PANE PATTERNS



mat dre



decomat graphite

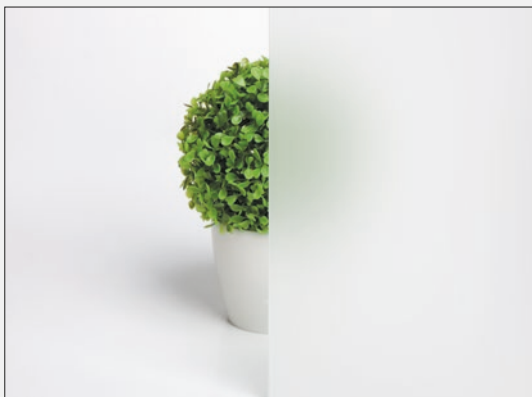

white frost laminated VSG 22.1, plain on both sides

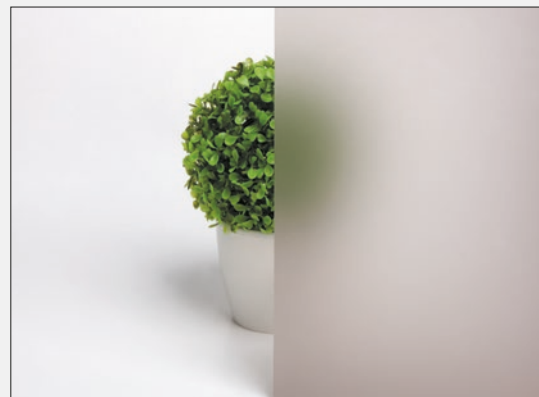

decomat brown



window blind



chinchila



white bark

PRICES

Prices and availability of glass panes are presented on pages with door leaves. The glass in the door leaves of our collections have obverse and reverse (except VSG 22.1 and VETRO E).

ARCHITRAVES AND SKIRTING BOARDS



MASKING ARCHITRAVE SOFT NATURA

application: fixed door frame SOFT natura



Set contains (for one side of the door):

horizontal element and two vertical elements, plastic clips, pins and clips.

PRICE OF ANGULAR ARCHITRAVE:

» angular architrave SOFT natura

Price for a set for one side of the door leaf

Price of the angular architrave for double-leaf doors +30%

In order to purchase angular architrave, it is necessary to specify side of the door leaf, on which, components will be mounted.

ARCHITRAVES

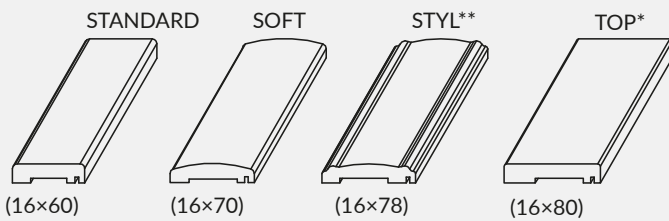

application: fixed door frame, fixed door frame SOFT

Set contains (for one side of the door):

one horizontal and two vertical components, pins and clips.
Architrave are packed in a cardboard boxes.

Connection of angular architrave

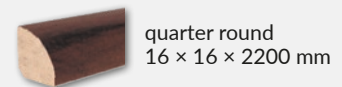
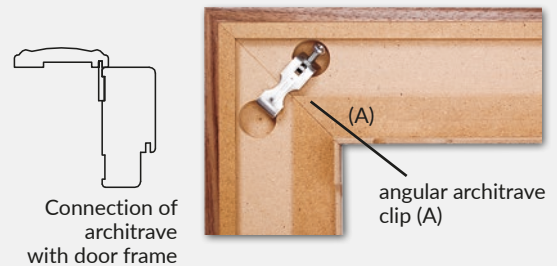

quarter round
16 × 16 × 2200 mm



SOFT quarter round,
SOFT natura
11 × 18 × 2200 mm

SKIRTING BOARDS



QUARTER ROUNDS

Quarter round are used to mask the angular connection between the wall and the door frame.

A single item constitutes a trade unit.

LPP2W LPP3W LPP1W LPP4W

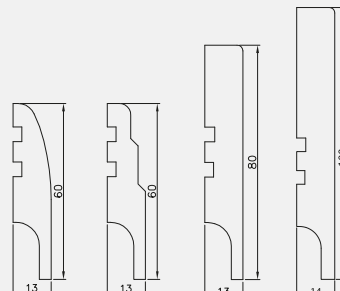

Lenght of LPP4W is 2,40 mb
It is made of moisture resistant board.

VENTILATION ACCESSORIES AND OTHER

VENTILATION SLEEVES FOR PANEL DOORS

There is possibility to purchase a set (5 pcs) of ventilation sleeves.
DRE-Cell Decor, 3D veneer, CPL laminate and Finish veneer - white, oak, calvados, brown, silver, grey/.
NATURA - satin silver, satin gold, silver, gold.



VENTILATION SLEEVES FOR FRAME CONSTRUCTION DOOR LEAF

For frame construction door leaf, except VETRO, it is possible to use metal or plastic ventilation sleeves (3 sleeves for "60", 4 sleeves for "70", 5 sleeves for "80" - "100")

METAL VENTILATION SLEEVES

stainless steel



PLASTIC VENTILATION SLEEVES



VENTILATION GRILLE

There is possibility to instal bathroom plastic ventilation grille, which is available in the following colours: white, beige, calvados, brown, silver, creamy, gray and ashen (except of frame construction doors, sliding system doors, fire resistant doors and SOLID, ENTER and GALERIA natura ALU) or aluminum ventilation grille (except for LACK and ASCADA). » plastic ventilation grille.

- » plastic ventilation grille
- » aluminum ventilation grille

net price gross price



plastic ventilation grille



aluminum ventilation grille



ventilation undercut

VENTILATION UNDERCUT

In all collections (except VETRO D, VETRO E, SOLID, SOLID RC2, ENTER, FIRE resistant door leaves, sliding doors, folding), ventilation undercut can be made upon request.

HINGE COVERS

» (set consist of 2 pcs. for 1 hinge)

Hinge covers are adjusted to hinges with a diameter of 13,5 mm.

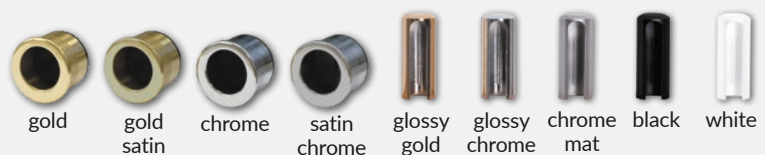

TECHNICAL INFORMATIONS

DOOR LEAF DIMENSION AND PLACEMENT OF HINGES

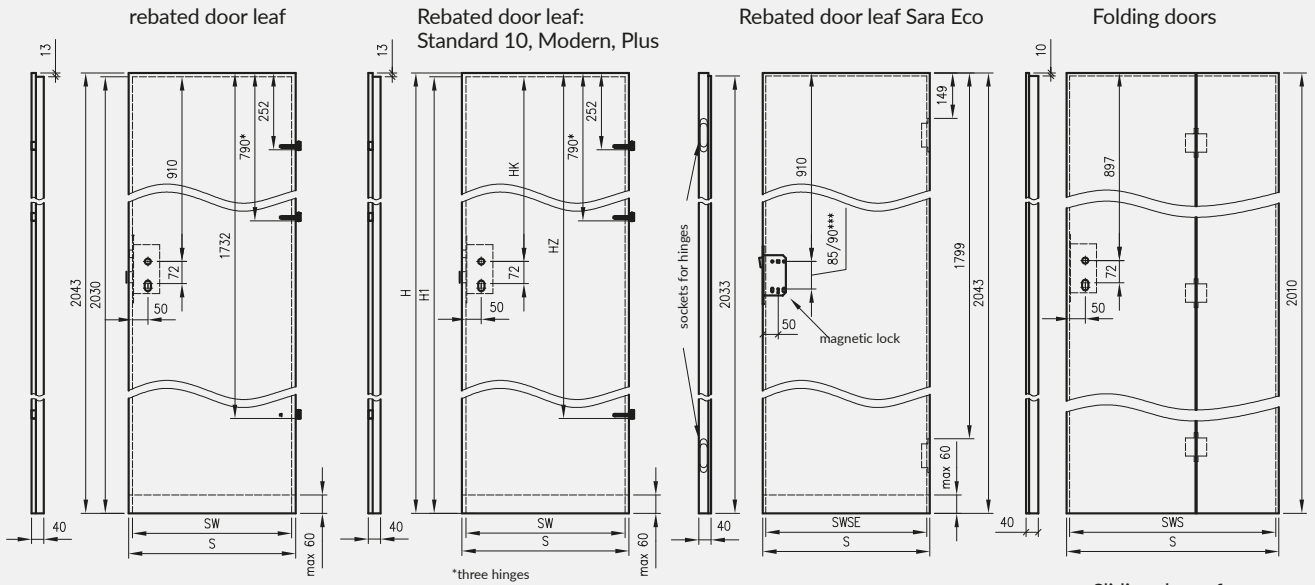

*three hinges

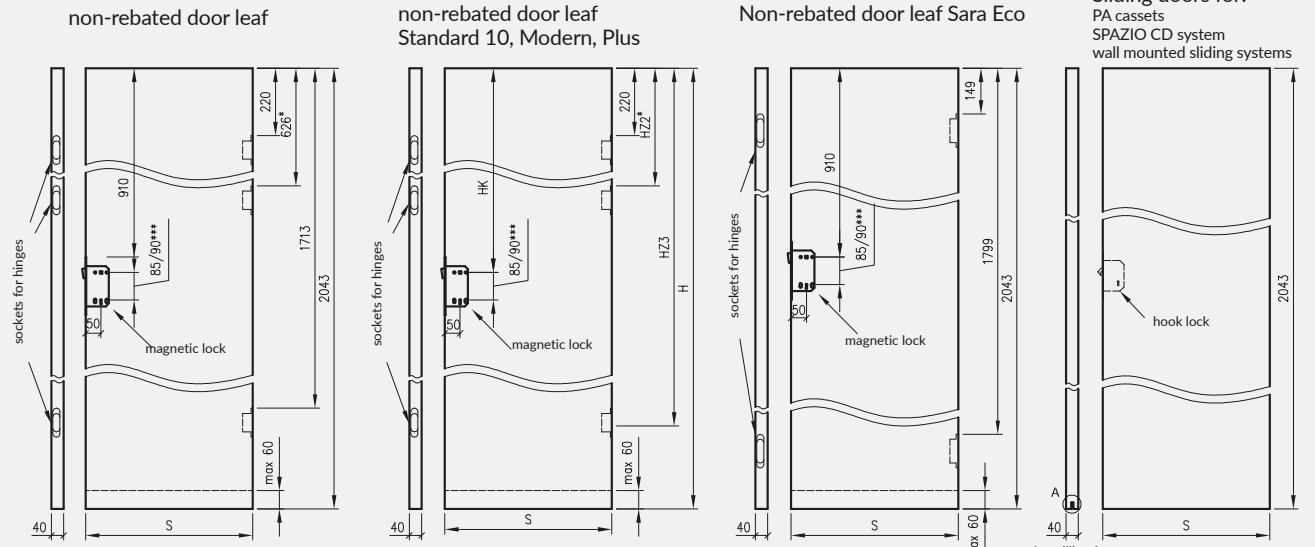

* optionally
 *** span in magnetic lock: 85 mm - in lock adapted for cylinder lock or 90 mm - in toilet lock and simple key lock

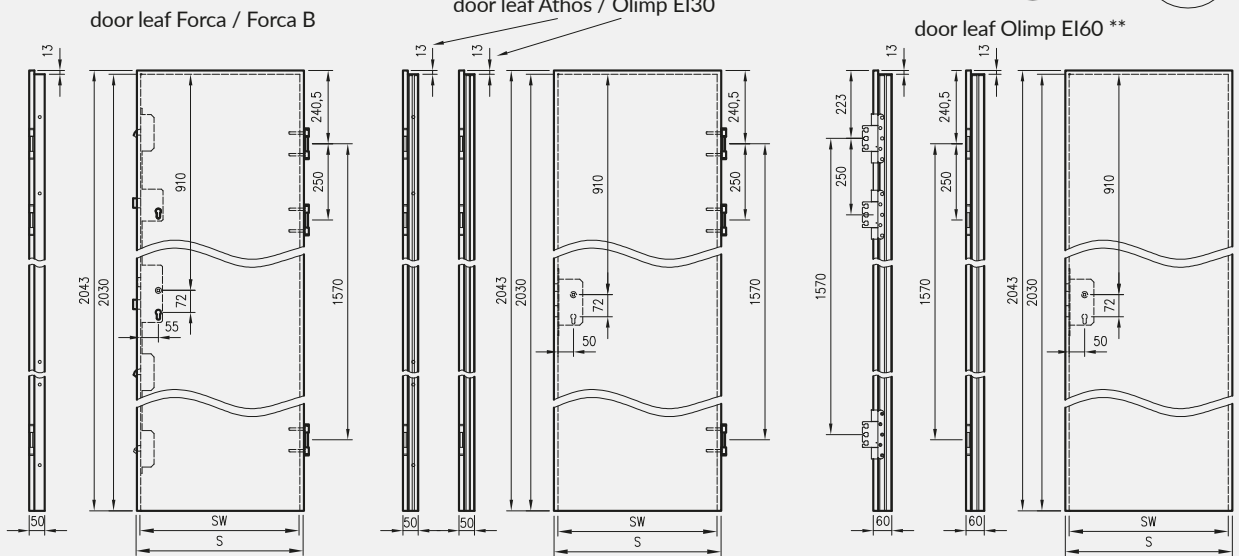
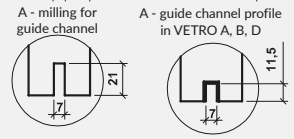

** Olimp E160 two options of hinges (depending on the width of the door)

TECHNICAL INFORMATIONS

DOOR LEAF WIDTH

Symbol of the door dimension	S	SW	SWSE	SWS
„60“	644	618	-	-
„70“	744	718	-	-
„80“	844	818	824	824
„90“	944	918	924	924
„100“	1044	1018	-	1024
„110*“	1144	1118	-	-

S - total door leaf width
 SW - width in the rebate (refers to rebated door leaf)
 SWSE - width in the rebate of Sara Eco door leaf
 SWS - width in the rebate of folding door leaf
 * - width "110" available only in Standard 10, Athos and Olimp door leaf

NOTE: Total width of "40" side panels is 444 mm.

ADDITIONAL WIDTH OF TECHNICAL DOORS

Symbol of the door dimension	S	SW
"90E" for OLIMP EI30, ATHOS, FORCA, FORCA B.	959	933
"90E" for OLIMP EI60	969	943

Orders, in investment standard, will be executed after consultations with Untypical Orders Department. By investment standard, is defined door frame passage, with opened door leaf at 90 degree, respectively for doors: interior "80" 800 mm, "90" 900 mm.

DIMENSIONS OF THE DOOR LEAF WITH 4 VARIABLE HEIGHTS

(refers to door leaf STANDARD 10 and collections MODERN and PLUS)

H	H1	HK	HZ	HZ2	HZ3
1983	1970	850	1672	606	1653
2043	2030	910	1732	626	1713
2110	2097	977	1799	647	1780
2240	2227	1107	1929	691	1910

H - total height of the door leaf
 H1 - door leaf height in the rebate
 HK - distance from the top rebate of door leaf to the axis of the handle
 HZ - distance from the upper edge of the door leaf to the mounting point of the third hinge

DOOR LEAF HEIGHT

2043 mm - total height of rebated and non-rebated door leaf (2010 for folding doors)
 2030 mm - total height of door leaf in rebate (2033 for Sara Eco rebated door leaf, 2000 for folding doors)
 2055 mm - total height of the door leaves with inverted rebate
 1983, 2043, 2110, 2240 mm - total possible height of STANDARD 10 door leaf and MODERN and PLUS collection (1970, 2030, 2097, 2227 mm - measured in the door leaf rebate)

SHORTENING OF DOOR LEAF

There is possibility to shorten door leaf by your own, up to 60 mm (there is no possibility to shorten following door leaf: VETRO, FIRE RESISTANT DOORS, FORCA B, door leaves of all collections in the sliding version, passive doors, glass doors, folding doors and door leaves with dropping seal).

CLEARANCE BETWEEN DOOR LEAF AND FLOOR

Standard clearance between door leaf and finished floor is 8 mm high (15 mm in FOLDE door leaf, 5-6 mm in OLIMP door leaf).

NOTES REFERED TO HINGE

In rebated door leaf: frame construction doors, entrance (Enter, Solid) and in the other collections with size wider than "90", 3 screw-in pivot hinges of \varnothing 13,5 mm are mounted. For other interior rebated leaves, there is possibility to choose 2 or 3 hinges.

In SOLID RC2, FORCA, FORCA B, ATHOS and OLIMP EI30 door leaves there are mounted 3 triple hinges.

The OLIMP EI60 leaves, depending on the width, are equipped with 3 three-part hinges or 3 SIMONSWERK hinges VX 7939/160.

Non-rebated door leaves come with pre-milled sockets for two or three hidden concealed hinges which are attached together with non-rebated door frame.

Sara Eco rebated and non-rebated door leaf come with pre-milled sockets for 2 concealed hinges that are attached together with the door frame.

Folding doors come with 3 hidden concealed hinges which join two parts of door leaf.

Door leaves with inverted rebate have sockets for two concealed hinges, which are packed together with door frame.

Non-rebated door leaf

REBATED DOOR LEAF

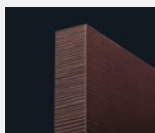

edge without rebate

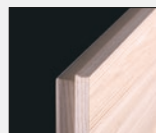

straight edge



magnetic lock



screw-in hinge



hinge concealed hinge

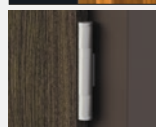

threefold hinge



threefold hinge



SIMONSWERK VX 7939/160 hinge

TECHNICAL INFORMATIONS

DOOR LEAF THICKNESS AND SELECTION OF PATENTED CYLINDER

Door leaf type	Door leaf thickness	proportion in the door leaf (W0/Z0)	reccommended** dimension of the patented cylinder (W/Z)	Refers to patented cylinder with door knob	
				Patented cylinder with a door knob inside (W/Z)	Patented cylinder with a door knob outside (W/Z)
rebated door leaf	40	14 / 26	25 / 40 26 / 36 26 / 41 30 / 40	25G / 40 26G / 36 26G / 41 30G / 40	25 / 40G 26 / 36G 26 / 41G 30 / 40G
rebated door leaf Sara Eco	40	24 / 16	35 / 30 36 / 26 36 / 31 40 / 30	35G / 30 36G / 26 36G / 31 40G / 30	35 / 30G 36 / 26G 36 / 31G 40 / 30G
Non-rebated door leaf	40	20 / 20	31 / 31 30 / 30 35 / 35	31G / 31 30G / 30 35G / 35	
Non-rebated door leaf Sara Eco	40	16 / 24	30 / 35 26 / 36 31 / 36 30 / 40	30G / 35 26G / 36 31G / 36 30G / 40	30 / 35G 26 / 36G 31 / 36G 30 / 40G
Door leaf with inverted rebate	40	27 / 13	40/25 41/26	40G / 25 41G / 26	40 / 25G 41 / 26G
Folding doors	40	17/23	30/35 31/36 30/40	30G / 35 31G / 36 30G / 40	30 / 35G 31 / 36G 30 / 40G
fire resistant Athos	50	21 / 29	31 / 41 35 / 40	31G / 41 35G / 40	31 / 41G 35 / 40G
Olimp EI30	50	18 / 32	30 / 45 31 / 46	30G / 45 31G / 46	30 / 45G 31 / 46G
Olimp EI60	60	28 / 32	40 / 45 41 / 46	40G / 45 41G / 46	40 / 45G 41 / 46G
fire resistant FORCA	50	22 / 28	35 / 40		
SOLID RC2	40,6	14 / 26,6	25 / 40 26 / 41 30 / 40		

Patented cylinders are reversible - that is 25/40 = 40/25, 26G/36 = 36/26G

**reccommended dimensions (assuming that backplate is 10 mm thick, and patented cylinder doesnt exceed 5 mm above backplate).

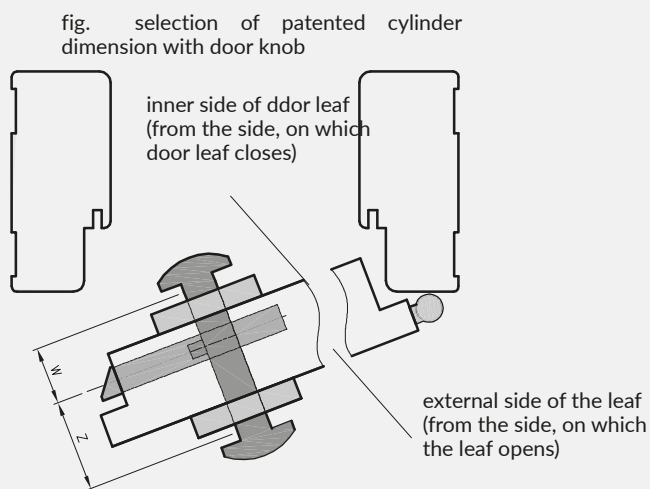
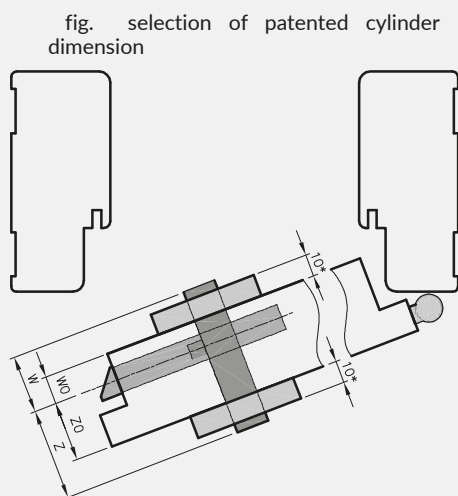

Dimension of patented cylinder is calculated using the following formula:

$W0 + \text{backplate thickness} + 2 \div 3 \text{mm} / Z0 + \text{backplate thickness} + 2 \div 3 \text{mm}$

where:

W0 and Z0 - values have been presented in the table above
thickness of the backplate - measured (presented values in above table assume that backplate is 10mm thick)

Selection of backplate with door knob - if we want to mount a knob on:

- the inner side of door leaf - symbol of the door knob must be next to "W" dimension (see column 5 in the table)

- the external side of the leaf - symbol of the door knob must be next to "Z" dimension (see column 6 in the table)

TECHNICAL INFORMATIONS

SINGLE LEAF REBATED DOOR

We offer left, right and central door leaf

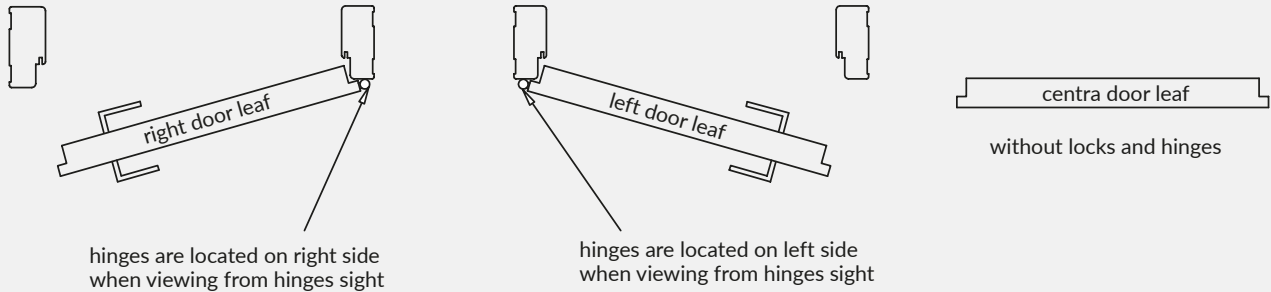

DOUBLE LEAF REBATED DOOR

We offer double leaf doors: right leaf - then right door leaf becomes an active one and left door leaf becomes inactive, and double left leaf - left leaf is an active one and the right one is inactive.

An active door leaf has a rebate and a lock as a standard option. In double leaf door there is available only straight edge.

Inactive door leaf comes with a "counter rebate" and additionally is equipped with a latch strike plate and a flush bolt as a standard fitting (A)

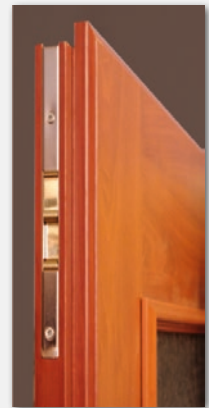
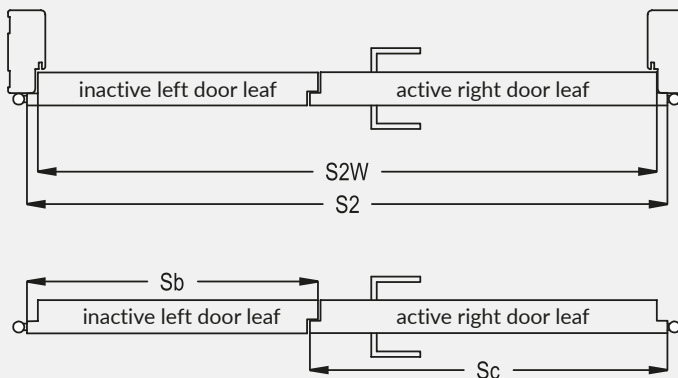

flush bolt (A)

Only door frames produced by DRE fit double-leaf doors, that is the reason that we recommend to our customers to buy doors as a complementary sets. Whole DRE set comprises of 2 door leaf and door frame.

$$\boxed{\text{price of double leaf door}} = \boxed{\text{leaf price} \times 2} + \boxed{\text{price of the fire resistance}}$$

Symbol of door dimension	dimension in [mm]		
	S2	S2W	combination* Sc+Sb
"100d"	1078	1052	644+444
"110d"	1178	1152	744+444
"120"	1278	1252	844+444; 644+644
"130"	1378	1352	944+444; 744+644; 644+744
"140"	1478	1452	1044+444; 844+644; 744+744; 644+844
"150"	1578	1552	944+644; 844+744; 744+844; 644+944
"160"	1678	1652	1044+644; 944+744; 844+844; 744+944; 644+1044
"170"	1778	1752	1044+744; 944+844; 844+944; 744+1044
"180"	1878	1852	1044+844; 944+944; 844+1044
"190"	1978	1952	1044+944; 944+1044
"200"	2078	2052	1044+1044

combination* possible combination of active (Sc) and inactive (Sb) leaf width

TECHNICAL INFORMATIONS

NON-REBATED DOOR LEAF - SLIDING VERSION

We offer left, right and central door leaf (door leaf without a lock and handle)

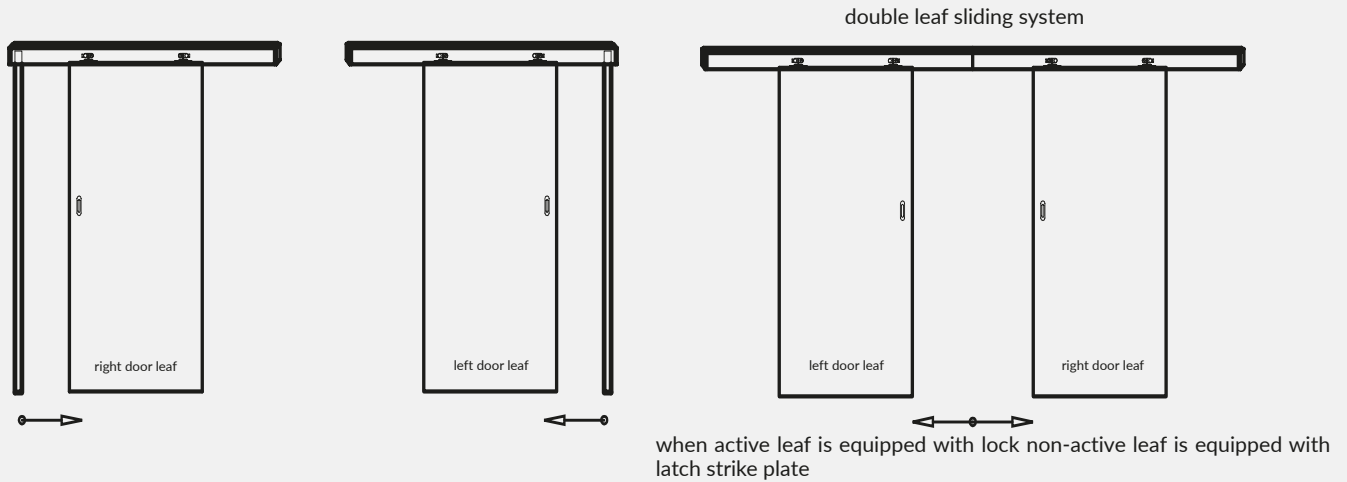

SINGLE NON-REBATED DOOR LEAF

We offer left, right and central door leaf

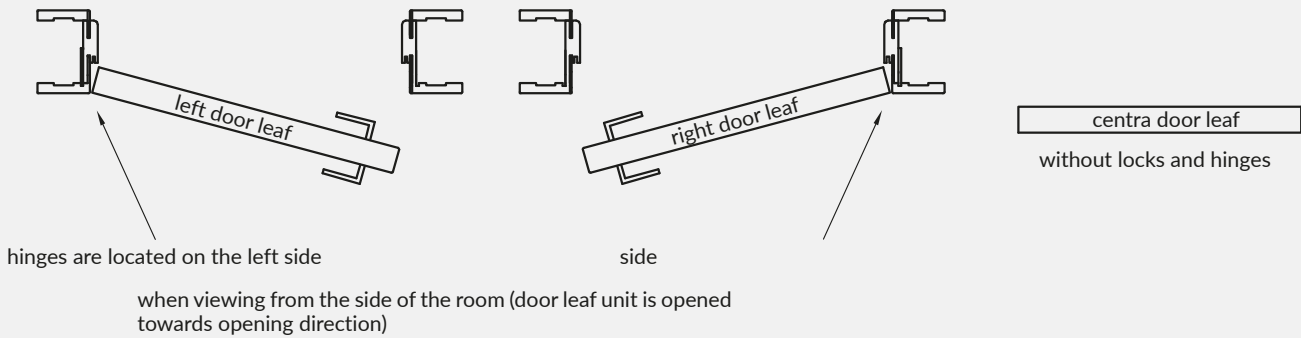

DOUBLE LEAF NON-REBATED DOOR

We offer double leaf doors: the right - then right door leaf becomes an active one and left door leaf becomes inactive, and double left leaf - left leaf is an active one and the right one is inactive.

An active door leaf has lock as a standard option. Inactive door leaf is equipped with a latch strike plate and a flush bolt as a standard fitting.

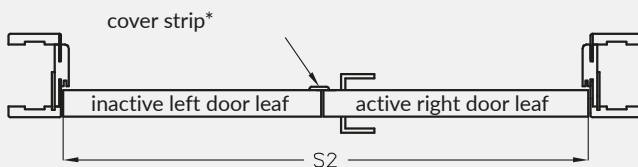

* for double non-rebated door leaf, there is possibility to purchase cover stripe width of cover stripe 30 mm

$$\text{price of double leaf door} = \text{leaf price} \times 2 + \text{price of the fire resistance}$$

Symbol of door dimension	dimension in [mm]	
	S2	combination* Sc+Sb
"120"	1291	644+644
"130"	1391	744+644; 644+744
"140"	1491	844+644; 744+744; 644+844
"150"	1591	944+644; 844+744; 744+844; 644+944
"160"	1691	1044+644; 944+744; 844+844; 744+944; 644+1044
"170"	1791	1044+744; 944+844; 844+944; 744+1044
"180"	1891	1044+844; 944+944; 844+1044

combination* - possible combination of active (Sc) and inactive (Sb) leaf width

TECHNICAL INFORMATIONS

CONSTRUCTION OF PANEL DOORS

- » door leaf frame made of coniferous wood or MDF
- » Core: stabilizing insert "honeycomb" (A), perforated chipboard (B) and in fire proof doors: chipboard
- » external board HDF 3 mm or external board HDF 4 mm (Finea, Finea B, ENTER, SOLID)
- » type of edge "karnies", straight or without rebate

- External boards of door leaf is finished with:
- a) in LACK, ASCADA collection - lacquered HDF board
 - b) in DRE-Cell veneer - decorative foil based on the polypropylene
 - c) in 3D veneer - 3D foil based on decorative paper
 - d) in CPL laminate - 0,15 -0,2 mm or 0,8 mm thick
 - in natura collection - natural veneer, secured with cured varnish in UV technology

Fire resistant door leaf Olimp EI30

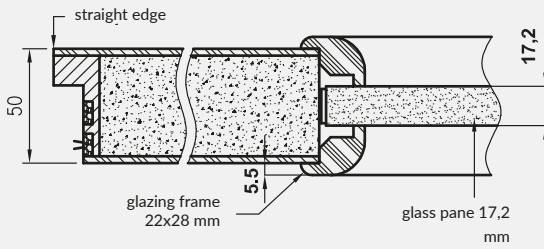

Fire resistant door leaf Olimp EI60

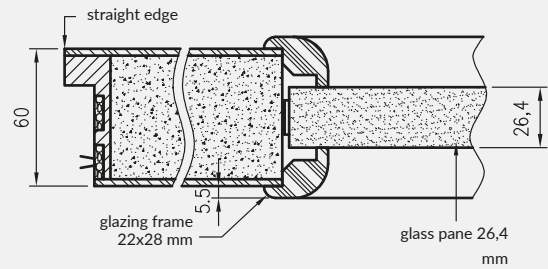

Anti-burglary door and fire-resistant door leaf Forca EI30

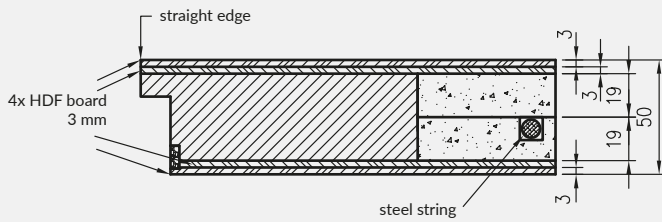

Anti-burglary door leaf Forca B

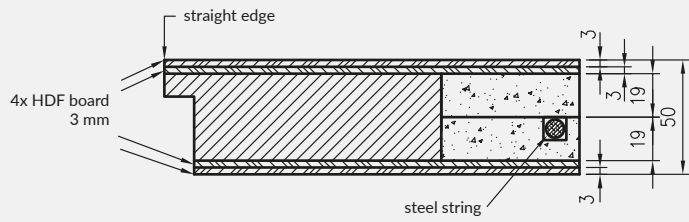

Anti-burglary door leaf SOLID RC2

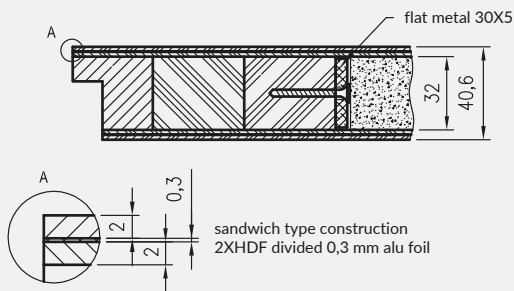

Fire-resistant door leaf Forca EI30

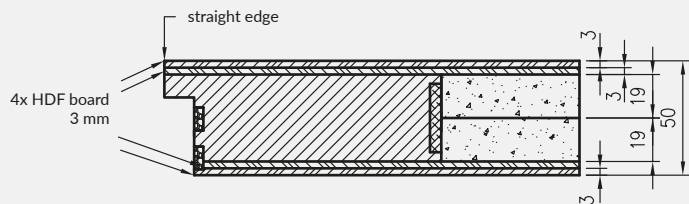

(A) stabilising insert "honeycomb"

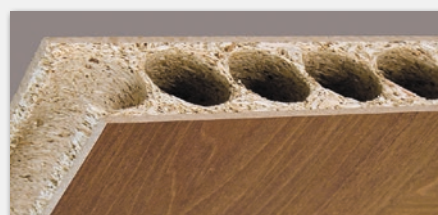

(B) perforated chipboard

TECHNICAL INFORMATIONS

FRAME CONSTRUCTION DOORS (IS NOT REFERRED TO VETRO A,B,C,D,F)

Frame construction door leaf is entirely made of MDF:

vertical stiles are made of 40 mm MDF (except TIZANO and TIXA)

horizontal rails (exterior) are made of 35 mm MDF

horizontal rails (interior):

22 mm MDF in door leaves models Auri, Piano, Even, Premium, Fosca, Sinco, Verso, Dova, Reva, Solte, Tizano, Tixa, Triesta*, Ena*, Verano* and Emena* (* in Ena 1-2, Triesta 1-2, Emena 1-2, Verano 1-2, collections horizontal rail is made of 35 mm MDF - it refers to rail located next to large glass pane. While in models Ena 3-5, Verano 3-5, Emena 3-5 and Triesta 3 such a construction is referred to two rails located next to large glass pane.

35 mm MDF in door leaf models Nestor, Elsa, Lexa, Scala, Trevi, Berge.

Horizontal cross-section of door leaf
Auri, Emena, Verano, Piano, Premium, Fosca, Sinco,
Verso, Ena, Even, Triesta, Dova, Reva, Solte

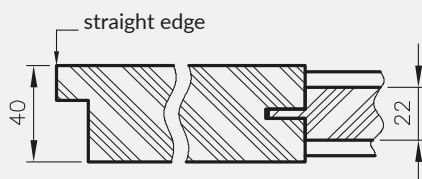

Horizontal cross-section of ELSA

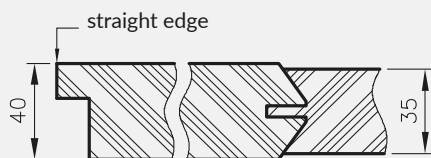

Horizontal cross-section of Tizano, Tixa

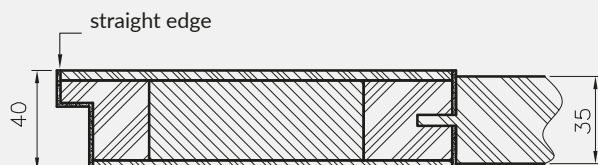

Horizontal cross-section of Ena, Verano,
Emena and Triesta (cross-section refers to
rail located next to large glass pane)

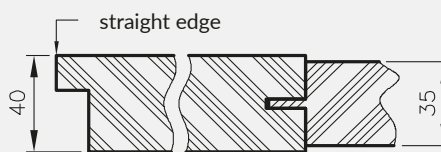

Horizontal cross-section of Nestor, Lexa

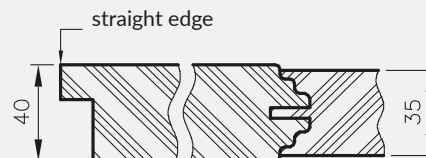

Horizontal cross section of the door leaf
Scala, Trevi, Berge
straight edge



FILLINGS OF FRAME CONSTRUCTION DOOR LEAF:

Scala A; Sinco - 4 mm glass pane, flat 4 mm HDF board

Scala B - 4 mm glass pane, 19 mm MDF profiled board

Elsa A - 4 mm glass pane, flat 4 mm HDF board

Elsa B - 4 mm glass pane, 19 mm MDF profiled board

Premium 1-3 - 4 mm glass pane

Premium 4-7, 12 - 4 mm glass pane, 4 mm HDF marquetrys made in door leaf colour

Premium 8-11, 13 - 4 mm glass pane, 4 mm HDF marquetrys coated with silver laminate

Piano 1-6 - 4 mm glass pane, 16 mm MDF profiled board

Piano 9-12 - 4 mm glass pane, 19 mm MDF profiled board

Fosca 1-3 - 4 mm glass pane, 4 mm HDF board coated with silver laminate

Fosca 4-6 - 4 mm HDF board coated with veneer in door leaf colour

Nestor, Lexa, Trevi, Berge - 4 mm glass pane, 19 mm MDF profiled board

Ena, Triesta, Auri, Verano, Emena, Even, Tizano, Tixa, Dova, Reva, Solte,

Verso - 4 mm glass

profile of 19 mm MDF board
(Scala B, Trevi, Piano 9-12, Elsa B,
Nestor, Lexa, Berge)

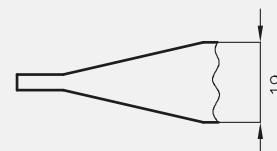

profile of 16 mm MDF
(Piano 1, 2, 5, 6)

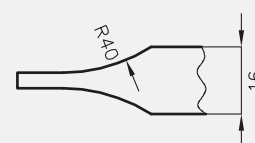

TECHNICAL INFORMATIONS

KICK PLATES

Kick plates so called „OKOPNIKI“ it is finishing solution for selected panel door models with straight edge. We offer door leaf covered with thin 0.6 mm metal sheets made of stainless steel optional bottom and middle panels. It is also possible that both of panels are instaled at the same time on the selected door leaf. Height of the panel is 300 mm. Door leaf with kick plates must be filled with perforated chipboard.



There is possibility to order door leaf with bottom panel and ventilation undercut.

NOTE: If you wish to place an order, please contact the Customer Service Department.

REMAINING TECHNICAL INFORMATIONS:

1. While maintaining standard dimensions of door leaf and door frame, clearance between "finished" floor and bottom edge of the door leaf is 8 mm. In order to reduce clearance, door frame should be appropriately shortened at the bottom (it doesnt refer to FOLDE and OLIMP)
2. Note! Prior to the purchase and assembly of construction woodwork, check whether the selected type of joinery meet technical requirements of the project and technical drawings, it is particularly necessary to make sure that the construction of walls and ceilings allows for the mounting of construction woodwork of weight specified in the table below:

	door leaf			DOOR FRAMES		other products	
	interior	entrance	fire-resistance	adjustable	fixed	Adjustable tunnel	Sliding system
Max weight	50 kg*	50 kg*	105 kg*	40 kg	20 kg	40 kg	20 kg

* max weight of single door leaf

3. Door leaf is wrapped in shrink film and the edges are additionally protected with Styrofoam or cardboard inserts.
4. Price of door leaf does not include door handles, backplates and patented cylinders (with the exception of SCALA A and B collections in rebated and non-rebated versions in DRE-Cell veneer and 3D veneer also excluding NESTOR and ELSA collections in rebated and non-rebated version in DRE-Cell veneer and 3D veneer, where handle and backplate come free-of-charge).
5. It is possible to purchase doors and door frames CENTRA (in this option there is no sockets for the lock and hinges - option is not available for fire doors, ENTER/SOLID, SOLID RC2, Sara Eco, FOLDE) at a price of a similar product equipped with hardware and pre-milled sockets. CENTRA door frames come with door seal. Set does not include hardware.

TECHNICAL INFORMATIONS

6. Under the current regulations, doors to the bathroom, wash room and a separate toilets must be opened to the outwards have width of at least 0,8 meter and height of 2 meter and also have on the bottom part openings with their total surface not smaller than 0,022 m², in order to fulfill correct air circulation. Door ventilation surface is the sum of the available ventilation components: ventilation grille (ensures the ventilation surface of 0.022 m² in all widths of doors) or ventilation undercut or ventilation sleeves, and the surface of the ground clearance between door leaf and the floor.

Ensuring ventilation surface for rebated doors**

Symbol of door leaf dimension	doors with ventilation sleeves		doors with ventilation undercut	
	ventilation surface of sleeves and the clearance 8 mm [m ²]	required clearance to meet ventilation requirements [in mm]	ventilation surface of the undercut and the clearance 8 mm [m ²]	required clearance to meet ventilation requirements [in mm]
"100"	0,011	19*	0,033	0
"90"	0,010	21*	0,029	1
"80"	0,009	24*	0,025	4
"70"	0,008	28*	0,021	14*
"60"	0,007	33*	0,018	35*

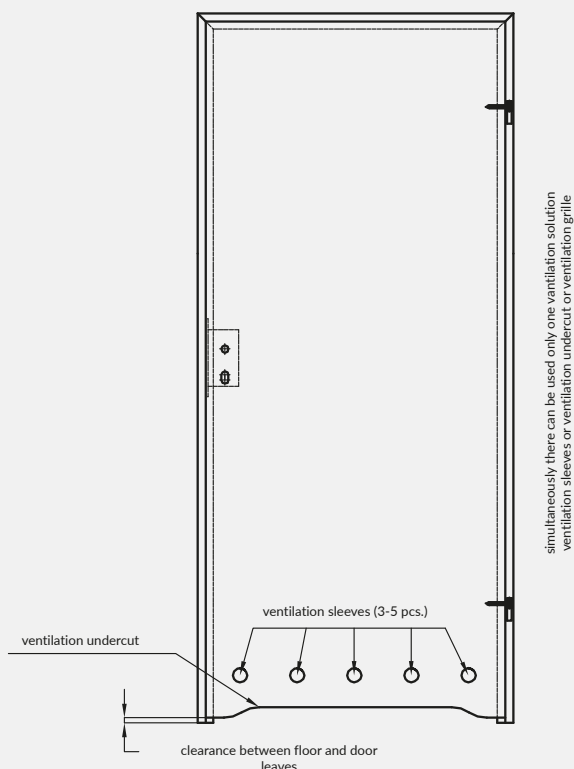

Ensuring ventilation surface for Sara Eco doors and all non-rebated doors

Symbol of door leaf dimension	doors with ventilation sleeves		doors with ventilation undercut	
	ventilation surface of sleeves and the clearance 8 mm [m ²]	required clearance to meet ventilation requirements [in mm]	ventilation surface of the undercut and the clearance 8 mm [m ²]	required clearance to meet ventilation requirements [in mm]
"100"	0,0112	19*	0,033	0
"90"	0,0104	21*	0,029	1
"80"	0,0096	23*	0,025	4
"70"	0,0082	27*	0,021	12*
"60"	0,0074	32*	0,018	31*

The above - stated required clearance height of the space under the door assures total ventilation surface of 0.022 m². The standard clearance for door leaf is 8mm high.

* it is necessary to increase the clearance to the specified height by shortening door leaf at the bottom (when such a shortening is possible - see**)

** Exceptions that are not included in the table (door leaf that can not be shortened):

- collection Vetro A and C - the use of ventilation undercut in the door with a width of "80" - "100" and a standard ground clearance of the door (8 mm) will fulfill ventilation requirements.
- collections Vetro B and D - do not meet ventilation requirements.
- sliding door leaf - due to design of the sliding system (distance from the wall/tunnel - about 12 mm), door leaf meet ventilation requirement without need for additional options.

There is no possibility to shorten double leaf doors and folding doors FOLDE.

VENTILATION UNDERCUT

standard ventilation undercut

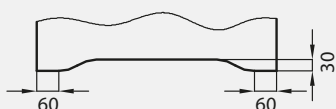

ventilation undercut in door leaf with natural veneer with „70“ - „90“ width

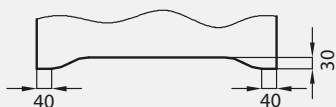

ventilation undercut in door leaf Vetro A and C

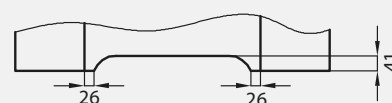

ventilation undercut in door leaf Vetro B

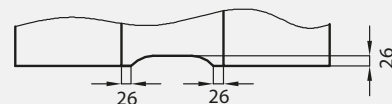



GALA 1 decormat, GALA 2 sandblasted glass, transparent stripes

Prices in catalog are stated in PLN.

The price list is valid from October 14.10. 2019.

Producer provides 24 months of warranty for door leaves and door frames.

pictures and visualisations used in the catalog present door leaf in the width of 80 cm (it doesn't refer to side panels). In the case of other door leaf widths, the proportions of the placement of the design of the collection, glazing, frames, millings, graphics will change. More technical informations and informations referred to assembly process are available in product guarantee card.

This product catalogue shall not constitute an offer under the regulations of the Civil Code and is published only for information purposes. Information provided in this catalogue was up-to-date on the day the catalogue was published. Due to the company policy of constant development DRE reserves the right to introduce (without prior notice) of changes to technical parameters, equipment, extended warranty conditions and product specification. The actual colours may vary from the colours printed in this catalogue. We reserve the right to errors in print.

Technical approvals:

Technical Approval ITB AT-15-6243/2015 (rebated interior doors)

National Technical Assessment ITB-KOT-2019/0860 issue 1 (sliding system)

Technical Approval ITB AT-15-8693/2011 (non-rebated interior doors)

National Technical Assessment ITB-KOT-2018/0633 release 1 (FORCA, ATHOS fire doors)

Technical Approval ITB AT-15-8359/2010 (glass doors)

Technical Approval ITB AT-15-9673/2016 (folding doors and sliding system glass doors)

National Technical Assessment ITB-KOT-2017/0011 edition 2 (ENTER / SOLID / SOLID RC2)

National Technical Assessment ITB-KOT-2018/0407 issue 1 (OLIMP)

PN-EN 14351-2: 2018-E12 (interior doors)



SALE POINT



82-300 Elbląg - Gronowo Górne, ul. Nefrytowa 4
Headquarters: phone 55 236 42 58
Customer service department: phone 55 236 42 42 to 48
fax 55 236 42 51
Marketing department: phone 55 236 42 40
working hours: 8:00 - 16:00
e-mail: dre@dre.pl, eksport@dre.pl www.dre.pl